

Basic specification	
Rated Power (W)	130
RATED VOLTAGE (Vdc)	36
RATED CURRENT / NO LOAD CURRENT (Arms)	5.6±1 / 0.55±0.2
RATED SPEED / NO LOAD SPEED (RPM)	3000±10% / 4400±10%
RATED TORQUE / MAX TORQUE (N.m)	0.45 / 1.1
MOTOR NUMBER OF POLES / PHASE	8 / 3
BACK EMF (Vrms/Krpm)	5.6±10%
IP CODE (Integrated servo motor)	IP20
WEIGHT (Kg)	1.25
Operating Environment	
Ambient Temperature	0°C ~ 40°C
Ambient Humidity	MAX 90%RH (no condensation)
Insulation Resisitance	100 MΩ (under normal temperature and humidity)
PERMISSIBLE RADIAL+AXIAL FORCE	
AXIAL FORCE - Fa (N)	15
RADIAL FORCE - Fr (N)	75
DISTANCE r (mm)	20

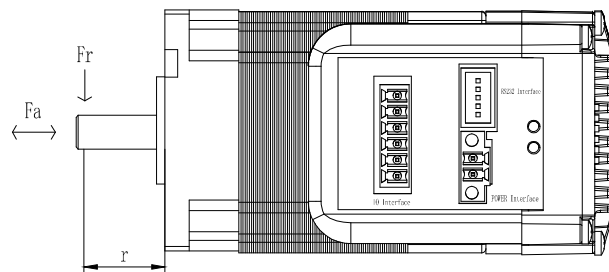

Top View

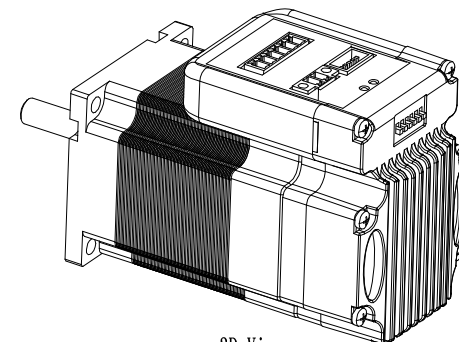

3D View

Leadshine Technology Co.Ltd

ISV-B23130T-S21
Integrated servo motor