

PROXIMITY SWITCH



接近开关 PROXIMITY SWITCH

接近开关型号说明 Model explanation of proximity switch

LM 18 _ 30 05 N A □ / L
1 2 3 4 5 6 7 8

开关类别 Switch category	输出形式 Output form
Lm: 电感式 Inductance type Cm: 电容式 Capacitance type Sm: 霍尔式 Hall type Am: 安全防爆式 Safety Explosion-proof type Xm: 模拟线性式 Mimic Linear type Hm: 舌簧式 Reed type Ru: 超声波 Ultrasonic type	N: 三线直流 NpN负逻辑输出 Three-wire Dc NpN Output P: 三线直流 PnP正逻辑输出 Three-wire Dc PnP Output L: 二线直流输出 Two-wire Dc Output : 交流二线输出 Ac Two-wire Output J: 继电器触点输出 Relay Contact Output Np: NpN+PnP 双输出 NpN+PnP Double Output
外形代号 Outward appearance code	输出状态 Output state
□: 圆柱型 Cylinder type F□: 角柱型及平面安装型 Angular Column Type And Plane Installation Type	A: 常开(no) normally Open (no) B: 常闭(nc) Normally Close (nc) C: 一开一闭(no-nc) normally Open-Normally Close(no+nc) Mu: 模拟电压 Mimic Voltage Mi: 模拟电流 Mimic Current Mui: 电压+电流 双输出 Voltage+Current
工作电压 Working voltage	附属功能 Subsidiary functions
30:6-36VDC 310:5-24VDC 320:12-60VDC 330:10-30VDC 340:10-55VDC 350:10-60VDC 360:5-36VDC 20:90-250VAC 210:24-250VAC 220:380VAC40:12-240VDC/24-240AC 50:特殊电压: Special voltage	T: 带航空插座 with aviation connector Y: 防水、防油 water proof, oil proof L: 特殊要求 special requirement H: 耐高温 high temp resistance R: 环形 ring type
检测距离 Detection distance	远距离 Long-distance
01:1mm 05:5mm 10:10mm	L: 远距离型 Long- distance

电感式接近开关工作原理 Working principle inductive proximity switch

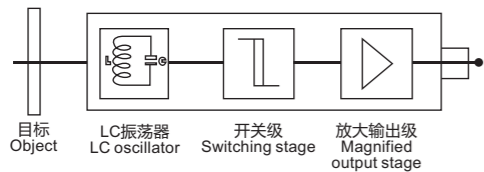

电感式接近开关由三大部分组成: 振荡器、开关电路及放大输出电路。振荡器产生一个交变磁场。当金属目标接近这一磁场, 并达到感应距离时, 在金属目标内产生涡流, 从而导致振荡器衰减, 以至停振。振荡器振荡及停振的变化被后级放大电路处理并转换成开关信号, 触发驱动控制器件, 从而达到非接触式之检测目的。

目标离传感器越近, 线圈内的阻抗就越大, 阻抗越大, 传感器振荡器的电流越小。

Inductive proximity switch is composed of three parts: oscillator, switch circuit and magnified output circuit. The oscillator will generate an alternating electric field. When metal object approaches this electric field and reaches the induction distance, whirlpool will generate in metal object, resulting in attenuation of vibration and then stop. The change of vibration and stop of oscillator is treated by begid stage magnified circuit and converted to switching sign, triggering driving con-contact detection.

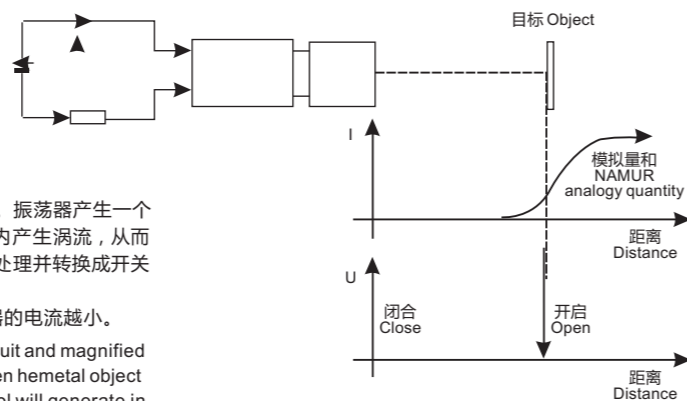

电感式接近开关的电流损耗, 随着与金属目标距离的减小而减小。 Current consumption of inductive proximity switch decreases proportional to the metal object distance.

接近开关应用图例 Application illustration of proximity switch

机加工中心的各种位置检测 Various location detection of machinery process center	瓶盖检测 Bottle lid detection	磨床的档块检测 Stopper detection of grinding machine	机器人手臂位置检测 Arm location detection of robot	检测纸包装内有无牛奶 Inspection of the existing of milk inside the paper package	限位检测 Spacing detection

接近开关 PROXIMITY SWITCH

接近开关的特性 Features of proximity switch

主要特性 Main features

以高频振荡型接近传感器(前面检测器)为代表例, 概略说明接近传感器的一般特性。



Take high frequency oscillation type proximity sensor (front detector) as representative example to briefly explain features of proximity switch

项目/Item	说明/Explanation	特性/Features	◆关于检测物体 / About detected object
检测物体的大小和检测距离 the size of detected object and detection distance	检测物体为正方形金属板, 厚度恒定(t=1mm), 改变其边长dmm时的检测距离X进行测定。 If the detected object is square metal sheet with constant thickness(t=1mm), detect at detection distance X when change its side length dmm.	<ul style="list-style-type: none"> 检测物体为大于标准检测物体时, 检测距离基本上恒定。 根据机种的不同, 有时和左边特性不同。 贯通型等, 以圆柱状金属棒为检测物体。 When the detected object is bigger than standard detected object, on the main, the detection distance is constant. According to different machine type, sometimes the features will be different with that mentioned on the left. To through type, the detection object is like cylinder metal bar. 	<ul style="list-style-type: none"> 检测物体的材料是非磁性金属时, 动作的距离要下降。但厚度为大于0.01mm左右的箔材料时, 会获得和磁性物体相同的检测距离, 而镀膜等级其薄时及无导电性时, 则不能检测。 镀层的影响检测物体具有镀层时, 请注意其检测距离就变了。 When the material of detected object is non magnetic metal, the distance of action should deseend. But when the foil material is approximately thicker than a.01mm, the detection distance will be the same as that of magnetic object. If the film plating is extremely thin or non-conductive, detection cannot be conducted. The effect of cladding material, when detected object has cladding material, take note of the changing of detection dinstance.
检测物体的厚度和检测距离 the thickness of detected object and detection distance	测定改变指定的标准检测物体形状的厚1mm时的检测距离Xmm(前面检测型) Detect at detection distance Xmm (front detector) when change the thickn ess of the assigned standard detected object 1mm.	<ul style="list-style-type: none"> 磁性金属(铁等)时, 厚度在1mm以上时, 检测距离基本上没有变化 For more than 1mm thick magnetic metal like iron, on the main, the detection distance will not chaneg. 	<ul style="list-style-type: none"> 为保护动作的可靠和寿命长, 请避免在有关规定以外的温度外界(户外)条件下使用, 接近传感器虽为防水结构, 若装上罩使用, 勿使水和水性切削油等淋到, 则可更好地提高可靠性及寿命。还请在有化学药剂, 特别是在强碱、酸、硝酸、铬酸、热浓硫酸等气候中使用。 In order to maintain reliable action and long service life, please avoid the (outdoor) occasion beyond the stiplated ambient temperature. Do not drench it with water-soluble cutting lubricant when it is used with cover, althouth the proximity sensor is waterproof. Do not use in the occasion with chemical agents, especially strong base, acid, nitric acid, hot strong sulfuric acid and so on .
检测物体材料和镀层等造成的影响 the effects resulted from the thickness of detected object and cladding material	标准检测物体的由于形状、尺寸因具材料。或各种镀引起的影响, 用检测距离Xmm的测定加以确认。 Because the detection to standard detected object will be effected by its shape, size, material, and various caldding material, confirm through detection distance Xmm measurement.	<ul style="list-style-type: none"> 铁以外的金属造成的检测距离及镀层的影响, 根据不同的机种而不同。 检测所有金属的机种时, 基本上不受镀层的影响。 The effects resulted from detection distance and cladding material of the metal excluded iron will be different according to different machine type. On the main, the machine type which detects all the metals will not be effected by cladding material. 	<ul style="list-style-type: none"> 为使接近传感器长期稳定工作, 和一般的控制器一样请实行下列定期检查。 1.被检测物体及接近传感器的安装位置, 偏移、松动, 变形的有无。 2.配线, 连接部位有无松动, 接触, 不良, 断线。 3.有无粘附金属粉末等积物。 4.使用温度条件, 周围环境条件有无异常。 5.检查距离有无异常。 In order to keep the proximity sensor to work stably for long time, the ollowing regular examinations should be performed just like general control. 1.Check the installation position of detected object and proximity sensor if any deviation, loosening of deformation exists. 2.Check the attached wires and connecting parts if any loosening, bad contact or wire breaking off exists. 3.Check if there is any metallic powder accumulation or not. 4.Chck if the temperature condition and surrounding environment condition are normal or not. 5.Chck if the detection distance is normal or not.

材料	检测距离
铁	100%
不锈钢	60%
黄铜	约40%
铝	约30%
铜	约28%

接近开关 PROXIMITY SWITCH

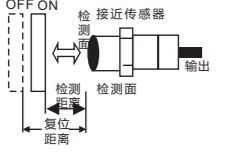
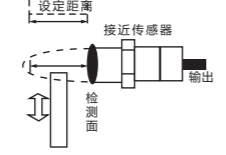
技术用词的说明 EXPLANATION OF TECHNICAL TERMS

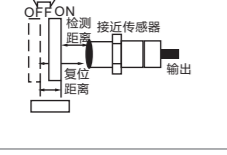
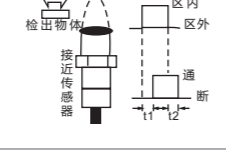
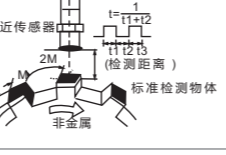
检测距离 Detection distance	设定距离 Setting distance	标准检测物体 Standard detected object
 <p>按指定方法移动检测物体，从基准位置(基准面)到测定动作复位的距离。 Move the detected object according to assigned method, the distance from the reference position (reference plane) to the detecting action(resetting)</p>	 <p>包括温度、电压影响在内，没有误动作从能实用的检测面到检测物体通过位置的距离。 Including the effects like temperature and voltage, without erroraction, the distance passed through from the practical detection surface to the objected objest.</p>	 <p>为测定基本性能作为标准的检测物体，形状尺寸、材料已决定的 Take as standard detected object to detect the basi erformance. The shape, size and material have be de termined.</p>
差动距离 Differential distance	响应时间 Response time	响应效率 Response frequency
 <p>到动作的距离和到复位的距离之差的绝对值。 The absolute value of the distance difference between the distance to action and the distance to resetting</p>	 <p>T1:检测物体进入动作区内，从接近传感器成为动作状态到出现输出的时间。 T2:从离开动作区到输出消失为止的时间。 T1: When the objected object enters the action zone, the time from proximity sensor being in action state to output appearance. T2: The time from leaving action zone to output disappearance.</p>	 <p>反复接近检测物体时，能得出跟踪它的输出每秒次数。测定方法概略如上图。 Work out the tracking output times per second repeatedly approaching the detected object, Brief detection method sees the above diagram.</p>

串联、并联 SERIES CONNECTION AND PARALLEL CONNECTION

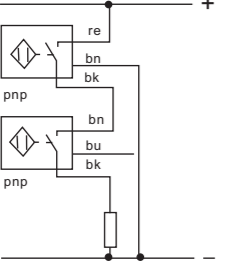
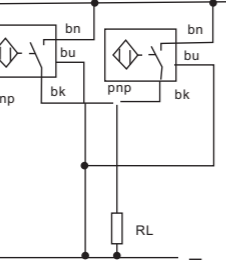
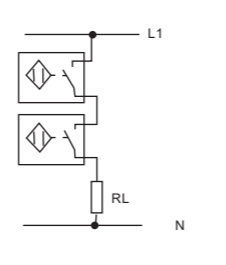
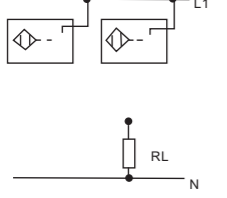
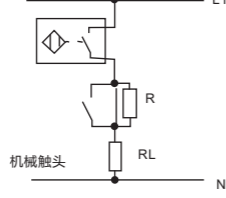
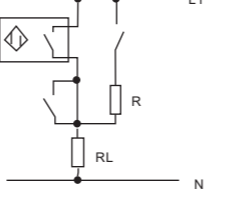
<p>★ 三线电流与三线直流传感器的串联 Series connection of three-wire DC and therr-wire DC sensor</p> 	<p>★ 三线电流与三线直流传感器的并联 Parallel connection of three-wire DC and therr-wire DC sensor</p> 	<p>★ 两线交流传感器的串联 Series connection of two-wire AC sensor</p> 
<p>◆ 两线交流传感器的并联 Parallel connection of two-wire AC sensor</p> 	<p>◆ 机械开关与交流传感器的串联 Series connection of machinery switch and AC sensor</p> 	<p>◆ 机械开关与交流传感器的并联 Parallel connection of machinery switch and AC sensor</p> 

接近开关 PROXIMITY SWITCH

主要特征 Main features

- 体积小 Compact volume
- 重复定位精度高 High precision of repeated location
- 外形结构多样 Diversified exterior structures
- 抗干扰性能好 Good performance of anti-interference
- 输出形式多 Many output forms
- 开关频率高 High on-off frequency
- 电压范围宽 Wide voltage range
- 防尘、防震、防水、防油 Dust proof, vibration proof, water proof and oil proof
- 具备短路保护，反连接保护 With short-circuit protection and inverted connecting protection
- 使用寿命长 Long service life

正确使用和安装及注意事项 Correct use, installation and cautions

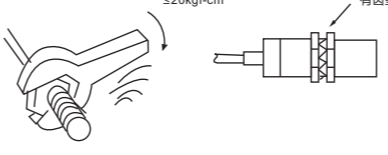
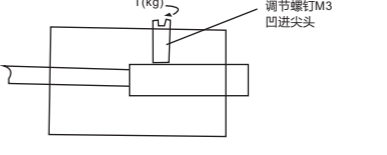
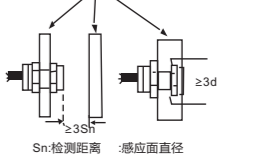
 <p>≤20kgf-cm 有齿垫圈</p>	 <p>T(kg) 调节螺钉M3 凹进尖头</p>	 <p>金属 Sn:检测距离 d:感应面直径</p>
<p>✦ 螺纹式开关的安装 Mounting screw switch</p> <p>✦ 安装开关时不可采用大力距紧固，紧固时请务必采用齿垫圈 Do not tighten with over-torque when mounting the switch, Adopt toothed washer then tightening</p>	<p>✦ 无螺纹式柱型开关的安装 Mounting non screw type pillar switch</p> <p>✦ 采用调节螺钉时，紧固力矩请用2-4kgf-cm以下安装 When adopt adjusting screw, the tightening torque should be within 2-4kgf-cm.</p>	<p>✦ 防止非检测物体的干扰 Protection against the interference of non detected object</p> <p>✦ 在金属件上安装接近开关时，请务必参照下图，所示预留一定空间，以避免开关产生误动作 When mounting the proximity switch in the metal part, do refer ti the following diagram. Remain acertain space in svdnce according to the shown diagram so as to prevent the switch from error action</p>

正确使用和安装及注意事项 Correct use, installation and cautions

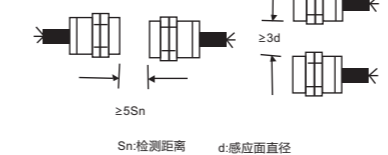
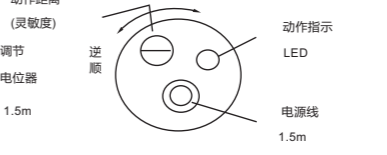
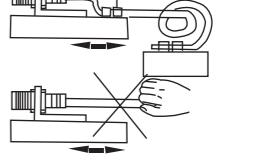
 <p>≥5Sn Sn:检测距离 d:感应面直径</p>	 <p>动作距离(灵敏度) 调节电位器 1.5m LED 电源线 1.5m</p>	
<p>✦ 螺纹式开关的安装 Mounting screw switch</p> <p>✦ 安装开关时不可采用大力距紧固，紧固时请务必采用齿垫圈 Do not tighten with over-torque when mounting the switch, Adopt toothed washer then tightening</p>	<p>✦ 开关动作距离(灵敏度)可调节 Adjustable switch actiondistance (sensitivity)</p> <p>✦ 接近开关可通过微调电位器调节动作距离(灵敏度)。顺时针动作距离增大(灵敏度减低)，逆时针，反之，切忌在动作距离最大临界状态下使用 The action distance (sensitivity) of proximity switch can be adjusted by the means oltrimming potentiometer, increase the action distance and reduce sensitivity when turnclockwise, vice versa. Do not use in thecritical state of max. Action distance.</p>	<p>✦ 开关引线的防护 Gusrd of switch lead-wire</p> <p>✦ 按装开关时，请将离开开关10cm左右引线位置用线夹固定，防止开关引线受外力的作用损坏。 When mount switch, fix the lead-wire at a distomce anpit 10cm from the switch with wire clip so as to prevent the switch lead wire from damage from outer force.</p>

注意事项 Cautions

- 直流开关应使用绝缘变压器，并确保稳压电源纹波。
- 如有电力线动力线通过开关引线周围时，防止开关损坏或误动作，将金属管套在开关引线上并接地。
- 开关使用距离请设定在额定距离以内，以免受温度和电压影响。
- 严禁通电接线，应严格按接线图输出回路原理图接线。
- 用户如需要防水、防油、耐酸、碱、耐高温开关等特殊要求或其他规格应在订货时说明，并给定定做。
- Dc switch should adopt insulation transformer and ensure stabc voltage mains corrugation.
- If any electric power line or dynamic line passes through the surrounding of switch lead-wire, in order ot precent the switch from damage or error action ,cover the metal bushing on the switch lead-wire and ground it to the earth.
- Set the switch use distance within the rated distance to avoid the effects from temperature and voltage.
- Wiring while power-on is strictly prohibited. connecting the wires strictly according to the wiring diagram and output return elementary diagram.
- If there areany special requirements to the switch like water proof, oil proof, acid proof, base proof, high temperature proof of with any other specifications, the users are required togive clear indication when placing an order. we can produce according to the requirements of the user.

接近开关 PROXIMITY SWITCH

结构分类 Structural category 圆柱型 Cylinder type 插件型 Connector type

外形编号 Outward Appearance code LM8-□□T / LM8-□□T3 LM12-□T / LM12-□T3 LM18-□T

外形图例
Outward appearance illustration



外形尺寸
Overall dimensions

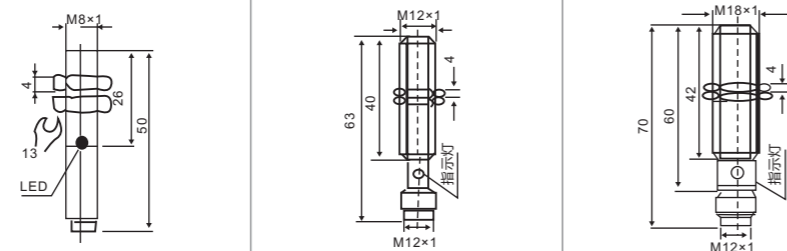

		检测距离 DETECTION DISTANCE				
		1mm	2mm	5mm		
Z a b u d o w n y 埋 入 式 Fl u s h	直流 DC 10- 30 VDC	NPN	NO	LM8-3001NAT	LM12-3002NAT	LM18-3005NAT
			NC	LM8-3001NBT	LM12-3002NBT	LM18-3005NBT
			NO+NC			
		PNP	NO	LM8-3001PAT	LM12-3002PAT	LM18-3005PAT
			NC	LM8-3001PBT	LM12-3002PBT	LM18-3005PBT
			NO+NC			
	交流 AC 90- 250 VAC	二 线 制 two wire system	NO	LM8-3001LAT	LM12-3002LAT	LM18-3005LAT
			NC	LM8-3001LBT	LM12-3002LBT	LM18-3005LBT
			NO+NC			
		SCR 可 控 硅 Control- lable silicon	NO		LM12-2002AT	LM18-2005AT
			NC		LM12-2002BT	LM18-2005BT
			NO+NC			
继电器输出 Relay output						
		检测距离 DETECTION DISTANCE				
		2mm	4mm			
W y s 非 埋 入 式 Non-Fl u s h	直流 DC 10- 30 VDC	NPN	NO	LM8-3002NAT	LM12-3004NAT	LM18-3008NAT
			NC	LM8-3002NBT	LM12-3004NBT	LM18-3008NBT
			NO+NC			
		PNP	NO	LM8-3002PAT	LM12-3004PAT	LM18-3008PAT
			NC	LM8-3002PBT	LM12-3004PBT	LM18-3008PBT
			NO+NC			
	交流 AC 90- 250 VAC	二 线 制 two wire system	NO	LM8-3002LAT	LM12-3004LAT	LM18-3008LAT
			NC	LM8-3002LBT	LM12-3004LBT	LM18-3008LBT
			NO+NC			
		SCR 可 控 硅 Control- lable silicon	NO	LM8-2002AT	LM12-2004AT	LM18-2008AT
			NC		LM12-2004BT	LM18-2008BT
			NO+NC			
继电器输出 Relay output						
输出电流 Control output	DC	150mA	200mA	300mA		
SCR/继电器 Relay						
输出电压降 Output voltage drop DC/AC		Typ DC (NPN PNP) 3 V lub mniej, typ dwuprzewodowy: 3,9 V lub mniej, AC 10 V lub mniej DC < 3 V, AC < 10V				
消耗电流 Consumption current		Typ DC (NPN PNP): 8 mA przy 12 V, 15 mA przy 24 V, AC 10 mA lub mniej DC < 15 mA, AC < 10 mA				
标准检测物体 Standard detected object		8×8×1(A3铁iron)	12×12×1(A3铁iron)	18×18×1(A3铁iron)		
重复精度 Repeated precision		0.01	0.01	0.02		
响应频率 DC/AC		500Hz/10Hz	400Hz/10Hz	200Hz/10Hz		
工作环境温度 Working environment temperature		-25°C~+70°C	-25°C~+70°C	-25°C~+70°C		
绝缘电阻 Insulation resistance		50MΩ	50MΩ	50MΩ		
外壳材料 Shell material		金属 Metal	金属 Metal	金属 Metal		
防护等级 Protection grade		IP67	IP67	IP67		
可替代国内型号 Alyemative model at home and abroad		E2E-X1R5-M1	E2E-X2E1-M1	E2E-X5E5-M1		

接近开关 PROXIMITY SWITCH

结构分类 Structural category 圆柱型 Cylinder type

外形编号 Outward Appearance code LM4/LM5 LM6 LM06 LM8

外形图例
Outward appearance illustration



外形尺寸
Overall dimensions

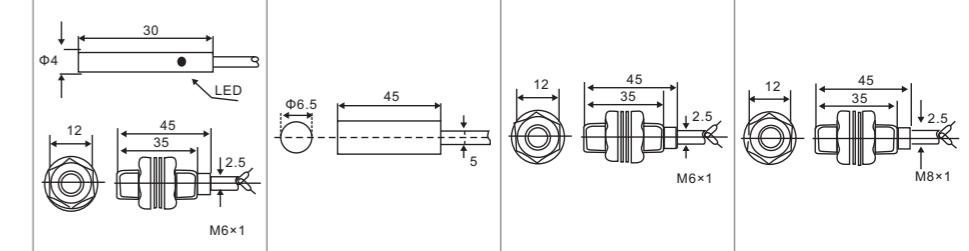

		检测距离 DETECTION DISTANCE					
		0.8mm/1mm	1mm	1mm	1mm	1mm	
埋 入 式 Fl u s h	直流 DC 10- 30 VDC	NPN	NO	LM4-300.8NA/LM5-3001NA	LM6-3001NA	LM06-3001NA	LM8-3001NA
			NC		LM6-3001NB		LM8-3001NB
			NO+NC				LM8-3001NC
		PNP	NO	LM4-300.8PA/LM5-3001PA	LM6-3001PA	LM06-3001PA	LM8-3001PA
			NC		LM6-3001PB		LM8-3001PB
			NO+NC				LM8-3001PC
	交流 AC 90- 250 VAC	二 线 制 two wire system	NO		LM6-3001LA		LM8-3001LA
			NC		LM6-3001LB		LM8-2001LB
			NO+NC				
		SCR 可 控 硅 Control- lable silicon	NO		LM6-2001A		LM8-2001A
			NC		LM6-2001B		LM8-2001B
			NO+NC				
继电器输出 Relay output							
		检测距离 DETECTION DISTANCE		1.5mm	2mm		
非 埋 入 式 Non-Fl u s h	直流 DC 10- 30 VDC	NPN	NO		LM6-3002NA	LM8-3002NA	
			NC		LM6-3002NB	LM8-3002NB	
			NO+NC				
		PNP	NO		LM6-3002PA	LM8-3002PA	
			NC		LM6-3002PB	LM8-3002PB	
			NO+NC				
	交流 AC 90- 250 VAC	二 线 制 two wire system	NO		LM6-3002LA	LM8-3002LA	
			NC		LM6-3002LB	LM8-3002LB	
			NO+NC				
		SCR 可 控 硅 Control- lable silicon	NO		LM6-2002A	LM8-2002A	
			NC		LM6-2002B	LM8-2002B	
			NO+NC				
继电器输出 Relay output							
输出电流 Control output	DC	200mA	200mA	200mA	200mA		
SCR/继电器 Relay							
输出电压降 Output voltage drop DC/AC		Typ DC (NPN PNP) 3 V lub mniej, typ dwuprzewodowy: 3,9 V lub mniej, AC 10 V lub mniej DC < 3 V, AC < 10V					
消耗电流 Consumption current		Typ DC (NPN PNP): 8 mA przy 12 V, 15 mA przy 24 V, AC 10 mA lub mniej DC < 15 mA, AC < 10 mA					
标准检测物体 Standard detected object		6×6×1(A3铁iron)	8×8×1(A3铁iron)	8×8×1(A3铁iron)	8×8×1(A3铁iron)		
重复精度 Repeated precision		0.01	0.01	0.01	0.01		
响应频率 DC/AC		500Hz	500Hz	500Hz	500Hz/25Hz		
工作环境温度 Workong environment temperature		-25°C~+70°C	-25°C~+75°C	-25°C~+70°C	-25°C~+75°C		
绝缘电阻 Insulation resistance		50MΩ	≥30MΩ	50MΩ	≥50MΩ		
外壳材料 Shell material		金属 Metal	不锈钢 Stainless steel	金属 Metal	金属 Metal		
防护等级 Protection grade		IP67	IP67	IP67	IP67		
可替代国内型号 Alyemative model at home and abroad					E2E-X1R5□□		

接近开关 PROXIMITY SWITCH

结构分类 Structural category

圆柱型 Cylinder type

外形编号 Outward Appearance code LM12 LM14 LM18 LM20

外形图例
Outward appearance illustration



外形尺寸
Overall dimensions

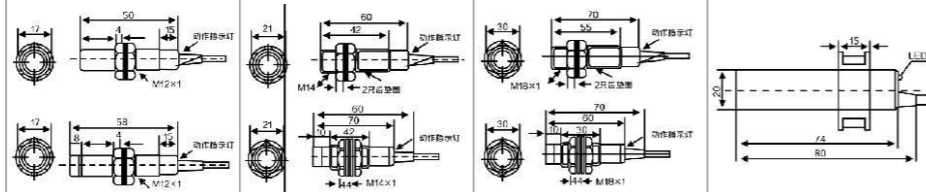

Z
a
b
u
d
o
w
a
n
y

检测距离 DETECTION DISTANCE		2mm	3mm	5mm	
直流 DC 10-30 VDC	NPN	NO	LM12-3002NA	LM14-3003NA	LM18-3005NA
		NC	LM12-3002NB	LM14-3003NB	LM18-3005NB
		NO+NC	LM12-3002NC	LM14-3003NC	LM18-3005NC
	PNP	NO	LM12-3002PA	LM14-3003PA	LM18-3005PA
		NC	LM12-3002PB	LM14-3003PB	LM18-3005PB
		NO+NC	LM12-3002PC	LM14-3003PC	LM18-3005PC
	二线制 two wire system	NO	LM12-3002LA	LM14-3003LA	LM18-3005LA
		NC	LM12-3002LB	LM14-3003LB	LM18-3005LB
		NO+NC	LM12-2002A	LM14-2003A	LM18-2005A
交流 AC 90-250 VAC	SCR 可控硅 Control-silicon	NO	LM12-2002A	LM14-2003A	LM18-2005A
	NC	LM12-2002B	LM14-2003B	LM18-2005B	
	NO+NC			LM18-2005C	

继电器输出 Relay output

W
y
s
非
埋
入
式
Non-Flush

检测距离 DETECTION DISTANCE		4mm	5mm	8mm	10mm	
直流 DC 10-30 VDC	NPN	NO	LM12-3004NA	LM14-3005NA	LM18-3008NA	LM20-3010NA
		NC	LM12-3004NB	LM14-3005NB	LM18-3008NB	LM20-3010NB
		NO+NC	LM12-3004NC	LM14-3005NC	LM18-3008NC	LM20-3010NC
	PNP	NO	LM12-3004PA	LM14-3005PA	LM18-3008PA	LM20-3010PA
		NC	LM12-3004PB	LM14-3005PB	LM18-3008PB	LM20-3010PB
		NO+NC	LM12-3004PC	LM14-3005PC	LM18-3008PC	LM20-3010PC
	二线制 two wire system	NO	LM12-3004LA	LM14-3005LA	LM18-3008LA	LM20-3010LA
		NC	LM12-3004LB	LM14-3005LB	LM18-2008LB	LM20-3010LB
		NO+NC	LM12-2004A	LM14-2005A	LM18-2008A	LM20-2010A
交流 AC 90-250 VAC	SCR 可控硅 Control-silicon	NO	LM12-2004A	LM14-2005A	LM18-2008A	LM20-2010A
	NC	LM12-2004B	LM14-2005B	LM18-2008B	LM20-2010B	
	NO+NC			LM18-2008C	LM20-2010C	

继电器输出 Relay output

输出电流 Control output	DC	200mA	200mA	200mA	200mA
SCR/继电器 Relay		300mA	300mA	300mA	300mA/1A

输出电压降 Output voltage drop DC/AC Typ DC (NPN PNP) 3 V 或 3 V 以下, typ dwuprzewodowy: 3,9 V 或 3,9 V 以下, AC 10 V 或 10 V 以下 DC < 3 V, AC < 10V

消耗电流 Consumption current Typ DC (NPN PNP): 8 mA 或 8 mA 以下, 15 mA 或 15 mA 以下, AC 10 mA 或 10 mA 以下 DC < 15 mA, AC < 10 mA

标准检测物体 Standard detected object 15×15×1(A3铁iron) 15×15×1(A3铁iron) 18×18×1(A3铁iron) 20×20×1(A3铁iron)

重复精度 Repeated precision 0.01 0.02 0.02 0.05

响应频率 DC/AC 400Hz/25Hz 300Hz/25Hz 200Hz/25Hz 200Hz/25Hz

工作环境温度 Working environment temperature -25°C~+75°C -25°C~+75°C -25°C~+75°C -25°C~+75°C

绝缘电阻 Insulation resistance ≥50MΩ ≥50MΩ 50MΩ 50MΩ

外壳材料 Shell material 金属 Metal 金属 Metal 金属 Metal ABS树脂 Resin

防护等级 Protection grade IP67 IP67 IP67 IP67

可替代国内型号 Alyemative model at home and abroad E2E-X5□□ LJ14A3-□□ LJ18A3-8-□□

接近开关 PROXIMITY SWITCH

圆柱型 Cylinder type

外形编号 Outward Appearance code LM24 LM30 LM34 LM35 LM38

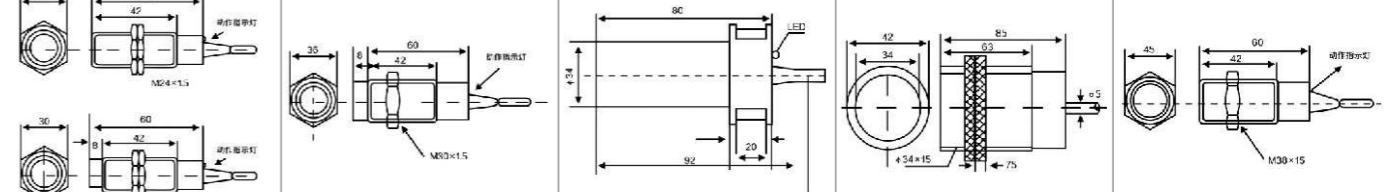

检测距离 DETECTION DISTANCE		8mm	10mm	12mm	
直流 DC 10-30 VDC	NPN	NO	LM24-3008NA	LM30-3010NA	LM38-3012NA
		NC	LM24-3008NB	LM30-3010NB	LM38-3012NB
		NO+NC	LM24-3008NC	LM30-3010NC	LM38-3012NC
	PNP	NO	LM24-3008PA	LM30-3010PA	LM38-3012PA
		NC	LM24-3008PB	LM30-3010PB	LM38-3012PB
		NO+NC	LM24-3008PC	LM30-3010PC	LM38-3012PC
	二线制 two wire system	NO	LM24-3008LA	LM30-3010LA	LM38-3012LA
		NC	LM24-3008LB	LM30-3010LB	LM38-3012LB
		NO+NC	LM24-2008A	LM30-2010A	LM38-2012A
交流 AC 90-250 VAC	SCR 可控硅 Control-silicon	NO	LM24-2008A	LM30-2010A	LM38-2012A
	NC	LM24-2008B	LM30-2010B	LM38-2012B	
	NO+NC	LM24-2008C	LM30-2010C	LM38-2012C	

检测距离 DETECTION DISTANCE		10mm	15mm	17mm	17mm	18mm	
直流 DC 10-30 VDC	NPN	NO	LM24-3010NA	LM30-3015NA	LM34-3017NA	LM35-3017NA	LM38-3018NA
		NC	LM24-3010NB	LM30-3015NB	LM34-3017NB	LM35-3017NB	LM38-3018NB
		NO+NC	LM24-3010NC	LM30-3015NC	LM34-3017NC	LM35-3017NC	LM38-3018NC
	PNP	NO	LM24-3010PA	LM30-3015PA	LM34-3017PA	LM35-3017PA	LM38-3018PA
		NC	LM24-3010PB	LM30-3015PB	LM34-3017PB	LM35-3017PB	LM38-3018PB
		NO+NC	LM24-3010PC	LM30-3015PC	LM34-3017PC	LM35-3017PC	LM38-3018PC
	二线制 two wire system	NO	LM24-3010LA	LM30-3015LA	LM34-3017LA	LM35-3017LA	LM38-3018LA
		NC	LM24-3010LB	LM30-3015LB	LM34-3017LB	LM35-3017LB	LM38-3018LB
		NO+NC	LM24-2010A	LM30-2015A	LM34-2017A	LM35-2017A	LM38-2018A
交流 AC 90-250 VAC	SCR 可控硅 Control-silicon	NO	LM24-2010A	LM30-2015A	LM34-2017A	LM35-2017A	LM38-2018A
	NC	LM24-2010B	LM30-2015B	LM34-2017B	LM35-2017B	LM38-2018B	
	NO+NC	LM24-2010C	LM30-2015C	LM34-2017C	LM35-2017C	LM38-2018C	

输出电流 Control output	DC	200mA	200mA	200mA	200mA	200mA
SCR/继电器 Relay		300mA	300mA	300mA	300mA	300mA/1A

输出电压降 Output voltage drop DC/AC Typ DC (NPN PNP) 3 V 或 3 V 以下, typ dwuprzewodowy: 3,9 V 或 3,9 V 以下, AC 10 V 或 10 V 以下 DC < 3 V, AC < 10V

消耗电流 Consumption current Typ DC (NPN PNP): 8 mA 或 8 mA 以下, 15 mA 或 15 mA 以下, AC 10 mA 或 10 mA 以下 DC < 15 mA, AC < 10 mA

标准检测物体 Standard detected object 24×24×1(A3铁iron) 30×30×1(A3铁iron) 34×34×1(A3铁iron) 40×40×1(A3铁iron) 40×40×1(A3铁iron)

重复精度 Repeated precision 0.05 0.05 0.05 0.1 0.1

响应频率 DC/AC 200Hz/25Hz 200Hz/25Hz 200Hz/25Hz 100Hz/15Hz 100Hz/15Hz

工作环境温度 Working environment temperature -25°C~+75°C -25°C~+75°C -25°C~+75°C -25°C~+75°C -25°C~+75°C

绝缘电阻 Insulation resistance 50MΩ 50MΩ 50MΩ 50MΩ 50MΩ

外壳材料 Shell material 金属 Metal 金属 Metal ABS树脂 Resin ABS树脂 Resin ABS树脂 Resin





防护等级 Protection grade IP67 IP67 IP67 IP67 IP67

可替代国内型号 Alyemative model at home and abroad LJ24A3-10-□□ E2E-X18M□ LJ38A4-18-□□

接近开关 PROXIMITY SWITCH



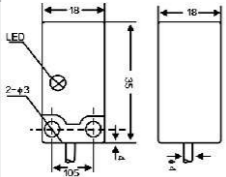
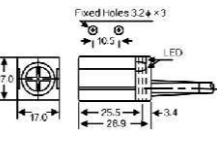
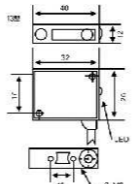
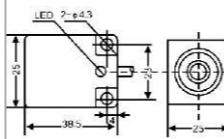

结构分类 Structural category

角柱型 Angular column type

外形编号 Outward Appearance code		LMF3	LMF4	LMF5	LMF6		
外形图例 Outward appearance illustration							
外形尺寸 Overall dimensions							
检测距离 DETECTION DISTANCE		5mm	5mm	2mm	8mm		
Z a b u d o w n y 埋入式 Flush	直流 DC 10-30 VDC	NPN	NO	LMF3-3005NA	LMF4-3005NA	LMF5-3002NA	LMF6-3008NA
			NC	LMF3-3005NB	LMF4-3005NB	LMF5-3002NB	LMF6-3008NB
			NO+NC		LMF4-3005NC	LMF5-3002NC	LMF6-3008NC
	交流 AC 90-250 VAC	PNP	NO	LMF3-3005PA	LMF4-3005PA	LMF5-3002PA	LMF6-3008PA
			NC	LMF3-3005PB	LMF4-3005PB	LMF5-3002PB	LMF6-3008PB
			NO+NC		LMF4-3005PC	LMF5-3002PC	LMF6-3008PC
			二线制 two wire system	NO	LMF3-3005LA	LMF4-3005LA	LMF5-3002LA
	SCR 可控硅 Control- lable silicon	VAC	NC	LMF3-3005LB	LMF4-3005LB	LMF5-3002LB	LMF6-3008LB
			NO				LMF6-2008A
			NO+NC				LMF6-2008B
继电器输出 Relay output							
检测距离 DETECTION DISTANCE				4mm	10mm		
W y s 非埋入式 Non-Flush	直流 DC 10-30 VDC	NPN	NO		LMF5-3004NA	LMF6-3010NA	
			NC		LMF5-3004NB	LMF6-3010NB	
			NO+NC		LMF5-3004NC	LMF6-3010NC	
	交流 AC 90-250 VAC	PNP	NO		LMF5-3004PA	LMF6-3010PA	
			NC		LMF5-3004PB	LMF6-3010PB	
			NO+NC		LMF5-3004PC	LMF6-3010PC	
			二线制 two wire system	NO		LMF5-3004LA	LMF6-3010LA
	SCR 可控硅 Control- lable silicon	VAC	NC		LMF5-3004LB	LMF6-3010LB	
			NO	LMF3-2005A		LMF6-2010A	
			NO+NC	LMF3-2005B		LMF6-2010B	
继电器输出 Relay output							
输出电流 Control output	DC	200mA	200mA	200mA	200mA		
SCR/继电器 Relay			300mA/1A		300mA		
输出电压降 Output voltage drop DC/AC		Typ DC (NPN PNP) 3 V lub mniej, typ dwuprzewodowy: 3.9 V lub mniej, AC 10 V lub mniej DC < 3 V, AC < 10V					
消耗电流 Consumption current		Typ DC (NPN PNP): 8 mA przy 12 V, 15 mA przy 24 V, AC 10 mA lub mniej DC < 15 mA, AC < 10 mA					
标准检测物体 Standard detected object		20×20×1(A3铁iron)	20×20×1(A3铁iron)	15×15×1(A3铁iron)	30×30×1(A3铁iron)		
重复精度 Repeated precision		0.02	0.03	0.03	0.05		
响应频率 DC/AC		400Hz/25Hz	300Hz	400Hz	200Hz/10Hz		
工作环境温度 Working environment temperature		-25℃~+75℃	-25℃~+75℃		-25℃~+75℃		
绝缘电阻 Insulation resistance		50MΩ	50MΩ		50MΩ		
外壳材料 Shell material		ABS树脂 Resin	ABS树脂 Resin	ABS树脂 Resin	ABS树脂 Resin		
防护等级 Protection grade		IP67	IP67		IP67		
可替代国内型号 Alyemative model at home and abroad		PS17-5PN	PS05-N, PS05-P		TL-N5ME□□		

接近开关 PROXIMITY SWITCH

角柱型 Angular column type

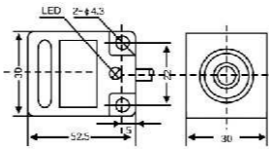
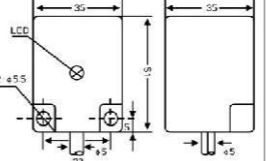
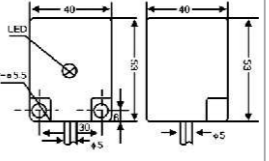
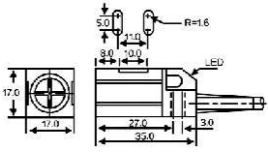
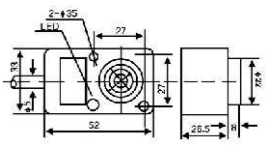
LMF7	LMF8	LMF10	LMF11	LMF12
				
				
10mm	10mm	15mm	5mm	
LMF7-3010NA	LMF8-3010NA	LMF10-3015NA	LMF11-3005NA	
LMF7-3010NB	LMF8-3010NB	LMF10-3015NB	LMF11-3005NB	
	LMF8-3010NC	LMF10-3015NC	LMF11-3005NC	
LMF7-3010PA	LMF8-3010PA	LMF10-3015PA	LMF11-3005PA	
LMF7-3010PB	LMF8-3010PB	LMF10-3015PB	LMF11-3005PB	
	LMF8-3010PC	LMF10-3015PC	LMF11-3005PC	
LMF7-3010LA	LMF8-3010LA	LMF10-3015LA	LMF11-3005LA	
LMF7-3010LB	LMF8-3010LB	LMF10-3015LB	LMF11-3005LB	
LMF7-2010A	LMF8-2010A	LMF10-2015A		
LMF7-2010B	LMF8-2010B	LMF10-2015B		
LMF7-2010C	LMF8-2010C	LMF10-2015C		
15mm	15mm	20mm		8mm
LMF7-3015NA	LMF8-3015NA	LMF10-3020NA		LMF12-3008NA
LMF7-3015NB	LMF8-3015NB	LMF10-3020NB		LMF12-3008NB
LMF7-3015NC	LMF8-3015NC	LMF10-3020NC		LMF12-3008NC
LMF7-3015PA	LMF8-3015PA	LMF10-3020PA		LMF12-3008PA
LMF7-3015PB	LMF8-3015PB	LMF10-3020PB		LMF12-3008PB
LMF7-3015PC	LMF8-3015PC	LMF10-3020PC		LMF12-3008PC
LMF7-3015LA	LMF8-3015LA	LMF10-3020LA		LMF12-3008LA
LMF7-3015LB	LMF8-3015LB	LMF10-3020LB		LMF12-3008LB
LMF7-2015A	LMF8-2015A	LMF10-2020A		LMF12-2008A
LMF7-2015B	LMF8-2015B	LMF10-2020B		LMF12-2008B
LMF7-2015C	LMF8-2015C	LMF10-2020C		LMF12-2008C
200mA	200mA	200mA	200mA	200mA
300mA		500mA		500mA
Typ DC (NPN PNP) 3 V lub mniej, typ dwuprzewodowy: 3.9 V lub mniej, AC 10 V lub mniej DC < 3 V, AC < 10V				
Typ DC (NPN PNP): 8 mA przy 12 V, 15 mA przy 24 V, AC 10 mA lub mniej DC < 15 mA, AC < 10 mA				
35×35×1(A3铁iron)	40×40×1(A3铁iron)	45×45×1(A3铁iron)	20×20×1(A3铁iron)	25×25×1(A3铁iron)
0.05	0.05	0.05	0.05	0.04
200Hz/15Hz	200Hz/15Hz	100Hz/15Hz	500Hz	200Hz/15Hz
-25℃~+75℃	-25℃~+75℃	-25℃~+70℃	-25℃~+70℃	-25℃~+70℃
50MΩ	50MΩ	50MΩ	50MΩ	50MΩ
ABS树脂 Resin	ABS树脂 Resin	ABS树脂 Resin	ABS树脂 Resin	ABS树脂 Resin
IP67	IP67	IP67	IP67	IP67
TL-N10M		TL-N20M□	PL-05N PL-05P	LJ1A-24