

TEK **NOMOTOR**

AUTOMATIC TOOL CHANGER ATC 71 CATALOGUE

RELEASE 1.0

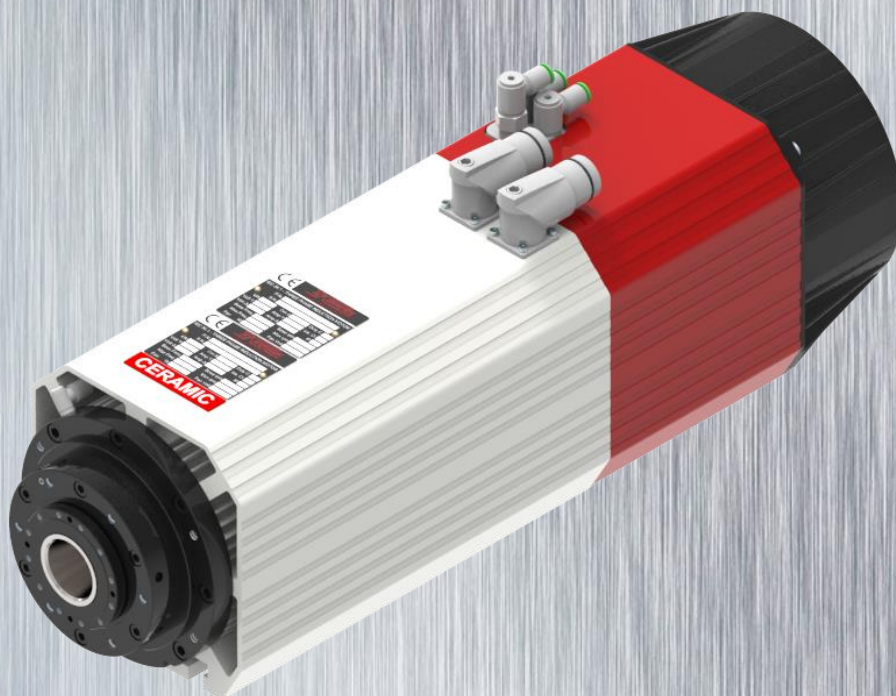

High **performance**

www.teknomotor.com

[Next page - Avanti](#)



BY CAR – IN MACCHINA – MIT DEM AUTO

From motorway – Dalla autostrada – Aus dem Autobahn:
A27 (Venezia-Belluno)
 Exit – Uscita – Ausgang
 Treviso Nord

BY TRAIN – IN TRENO – MIT DEM ZUG

Nearest station – Stazione più vicina – Bahnhof
 Feltre

BY PLANE – IN AEREO – MIT FLUGZEUG

Venezia (Marco Polo)

TEKNOMOTOR s.r.l.

Via Argenega, 31 - 32038 Quero Vas (BL) Italy

Tel. +39 0439 787950 – fax. +39 0439 780147

Partita IVA 00929130250

info@teknomotor.com

www.teknomotor.com

L'AZIENDA

Fondata nel 1983 la società Teknomotor s.r.l. progetta e produce da oltre 30 anni motori elettrici ed elettromandri per applicazioni meccaniche. Azienda in costante espansione, Teknomotor s.r.l. è attualmente impegnata sul mercato mondiale come fornitore di importanti aziende costruttrici i macchine per la lavorazione del legno, PVC e alluminio.

All'unità produttiva principale di Quero (BL) è stata recentemente affiancata un'ulteriore sede dedicata esclusivamente all'assemblaggio e collaudo finale dei motori. Tutte le fasi della produzione si avvalgono delle più avanzate tecnologie in materia di sistemi di disegno CAD, macchine utensili a controllo numerico e banchi prova computerizzati. Le lavorazioni meccaniche sono effettuate all'interno, in modo da garantire un costante controllo del processo produttivo unito ad un elevato grado di flessibilità che ci permette di soddisfare commesse di grande e piccola serie.

A ciò si aggiunge un'attenta scelta dei fornitori esterni, nostri partner commerciali, al fine di garantire un prodotto esente da difetti e di qualità superiore.

Fin dalla nascita Teknomotor s.r.l. si è distinta per la cortesia nei confronti della propria clientela e per la disponibilità nello sviluppare nuove soluzioni in stretta collaborazione con il committente.

COMPANY

Founded in 1983 Teknomotor s.r.l. has for over 30 years designed and developed electric motors and electrospindles for mechanical applications. As a constant growing Company, Teknomotor s.r.l. is currently engaged on worldwide market as supplier of important Companies specialized in the construction of machinery for the working of wood, PVC and aluminum. The established headquarters in Quero (BL) Italy, was recently enlarged with a new building dedicated exclusively to the assembly and final test of the motors. All the production phases use, at every stage, advanced technologies to ensure maximum quality, such as the CAD design software, machine tool with numeric control and computerized trials. The mechanical operations are carried out internally, in order to guarantee a constant control of the productive process and a high level of flexibility, which allows both large and small commissions to be fulfilled.

A careful selection of external suppliers, commercial partners, is made in order to guarantee an high quality product without defects.

From its birth Teknomotor s.r.l. has distinguished it self for the courtesy it shows its clients and for the commitment it has to develop new solutions in close collaboration with the buyer.

FIRMA

Die Firma Teknomotor s.r.l. wurde im Jahr 1983 gegründet. Seit mehr als 30 Jahren plant und produziert sie elektrische Motoren und Spindeln für mechanische Anwendungen. Teknomotor s.r.l. hat eine ständige Expansion bekannt und sie ist im Moment mit dem Weltmarkt beschäftigt. Sie versorgt mit ihren Motoren, wichtige und bekannte Firmen, die Holz-, PVC- und Aluminiummaschinen bauen. Der Hauptsitz in Quero (BL) war vor kurzem erweitert. In dem neuen Gebäude wird die Montage und die Prüfung gemacht. Vorgeschrittene Technologie wird benutzt, um die Qualität immer zu verbessern, wie z.B. CAD Planssysteme, numerische Kontrolle- Maschinen und computerisierte Prüfstände. Vorgeschrittene Technologie wird benutzt, um die Qualität immer zu verbessern, wie z.B. CAD Planssysteme, numerische Kontrolle- Maschinen und computerisierte Prüfstände. Die ganzen mechanischen Bearbeitungen sind in der Firma realisiert, so eine ständige Kontrolle der Produktion und hohe Flexibilität sind garantiert. Sowohl die kleinen Bestellungen als auch die größere können ohne Probleme erfüllt werden.

Es wird außerdem eine aufmerksame Wahl der Lieferanten, um ein Produkt ohne Defekte und von höherer Qualität zu garantieren. Von Geburt hat Teknomotor s.r.l. für ihre Höflichkeit und ihre Verfügung sich unterschieden, so sie, sehr schnell, immer neue Lösungen in Zusammenarbeit mit den Kunden vorschlagen und entwickeln kann.

AUTOMATIC TOOL CHANGERS GENERAL FEATURES

GENERAL INFORMATIONS

The Automatic Tool Changer electrospindle (ATC) have been designed to develop high speeds and powers with limited overall dimensions.

The standard models operate between 3000 rpm and 24000 rpm. The powers go from 3.8 to 12.0 kW.

These features make them ideal for use on automatic machines for machining wood, aluminum alloys and plastics.

ATCs are used mainly on CNC routers, machines for drilling, and for automation in general (Electrospindle mounted directly on anthropomorphic robot).

ATCs are cooled by an industrial electric fan 230V AC 50-60 Hz. On customer's request they can be cooled by compressed air using a special kit.

ATCs are pneumatically sealed and thus protected against the entry of any type of contaminants.

The stiffness of mechanical components, the speed of tool changing and the goodness of electrical components are key features of the ATC, which is produced by Teknomotor as a best in class product, for the most demanding costumers.

INFORMAZIONI GENERALI

Gli elettromandri con cambio utensile automatico (ATC - Automatic tool changers) sono stati progettati per sviluppare elevate velocità e potenze unite ad un ingombro limitato.

I modelli standard operano tra 3000 rpm e 24000 rpm. Le potenze disponibili variano tra 3.8 kW e 12.0 kW.

Queste caratteristiche li rendono ideali per l'impiego su macchine per la lavorazione del legno, delle leghe di alluminio e delle materie plastiche.

Gli ATC vengono impiegati prevalentemente nel settore delle macchine CNC routers, delle foratrici, dell'automazione in generale (Elettromandrino montato direttamente su robot antropomorfo).

Per le loro caratteristiche costruttive gli elettromandri sopportano un carico di tipo assiale, radiale o misto.

Gli ATC sono raffreddati per mezzo di un'elettroventola 230V-AC 50-60Hz di tipo industriale. Su richiesta possono essere raffreddati da aria compressa tramite un apposito kit.

Gli ATC sono pressurizzati e quindi protetti contro l'ingresso di qualsiasi tipo di contaminanti.

La rigidità dei suoi componenti, la velocità di cambio utensile e la qualità dei componenti elettrici sono caratteristiche peculiari di questo elettromandrino, che Teknomotor realizza come prodotto di prima scelta, per i clienti più esigenti.

ALLGEMEINE INFORMATIONEN

Die Elektrospindeln mit automatischem Werkzeugwechsel (genannt ATC = Automatic Tool Changers) wurden ausgelegt, um bei einem beschränkten Raumbedarf hohe Geschwindigkeiten bzw. Leistungen zu erreichen.

Die Standardmodelle sind zwischen 3000 und 24000 U/min tätig. Die verfügbaren Leistungen variieren zwischen 3.8 kW und 12.0 kW).

Dafür sind sie für den Einsatz an Maschinen für die Holz- bzw. Aluminiumlegierungs- und Kunststoffbearbeitung geeignet.

Die ATC kommen vorwiegend im Bereich CNC Routers, Bohrmaschinen und in der Automation im Allgemeinen (Elektrospindel direkt auf dem anthropomorphen Roboter installiert) zum Einsatz.

Dank ihrer Bauweise können die Elektrospindel einer radialen, axialen und miteinander kombinierten Belastung standhalten.

Die ATC werden mittels eines Elektroventils von 230V AC 50-60 Hz (industrieller Typ) gekühlt. Auf Anforderung können von einem Spezialset abgekühlt werden.

Da die ATC mit Luftdruck beaufschlagt werden, werden sie gegen den Eintritt von kontaminierenden Substanzen geschützt.

Die Steifigkeit ihrer Bauelemente, die Geschwindigkeit des Werkzeugwechsels und die Qualität der elektrischen Komponenten gehören zu den typischen Eigenschaften dieser Elektrospindel, die Teknomotor als Produkt erster Wahl für anspruchsvolle Kunden realisiert.



The electric fan ensures a constant cooling at every speed. All items are supplied with serial number and part number which refers to the mechanical and electrical test.

The compact design of the frame permits the ATC71 to be mounted in small spaces. All connectors are well ordered. The signal connector is separated from the power connector to prevent electromagnetic noise. All the sensors connectors are shielded and IP54 protected.

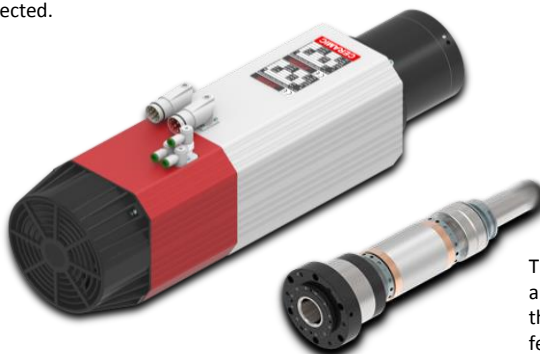

The smart design allows to replace the cartridge in a few steps.



The frame is robust and compact; it is designed to be stiff and light. The nose is pneumatically sealed against dust. The ceramic bearings assure high speeds, up to 24000 rpm.



TECHNICAL FEATURES TABLE	STATOR		ROTOR		SHAPE	COOLING	PROTECTION GRADE
	TYPE	INSULATION	TYPE	BALANCING GRADE			
Automatic tool changers (ATC71)	Asynchronous, 3 phases	F class	Squirrel cage	2.5 (ISO 1940)	Closed, from extruded aluminum profile	Electric fan cooling	IP 54

The electrospindles conform to the EMC EEC 89/336 directive, and to the EEC 89/392 machines directive. Moreover, the electrospindle cannot be put into service before the machine into which it is incorporated is declared to be in line with the second mentioned directive.

Gli elettromandri sono conformi alla direttiva EMC CEE 89/336 e alla direttiva macchine CEE 89/392 assumendo per quest'ultima che l'elettromandrino non può essere messo in servizio prima che la macchina, in cui sarà incorporato, sia stata dichiarata conforme alle disposizioni.

Die Elektrospindel entsprechen der EMV-Richtlinie EWG 89/336 und der Maschinenrichtlinie EWG 89/392. Diese letzte Norm setzt voraus, dass der Motor erst dann in Betrieb gesetzt werden darf, wenn die Maschine, in die er eingebaut wird, die dafür vorgesehenen Richtlinien erfüllt.

ATC71 ELECTROSPINDLES						
Power Nose	3.8/4.6 kW 380V 2 poles	5.0/6.0 kW 380V 4 poles	5.5/6.6 kW 380V 2 poles	7.5/9.0 kW 380V 4 poles	7.5/9.0 kW 380V 2 poles	10.0/12.0 kW 380V 4 poles
ISO30-SN	COMTC710001 Pag. 6	COMTC710020 Pag. 7	COMTC710004 Pag. 10	COMTC710022 Pag. 11	COMTC710003 Pag. 18	COMTC710024 Pag. 19
ISO30-LN	COMTC710007 Pag. 8	COMTC710021 Pag. 9	COMTC710008 Pag. 12	COMTC710014 Pag. 13	COMTC710009 Pag. 20	COMTC710025 Pag. 21
HSK63F-SN	-	-	COMTC710023 Pag. 14	COMTC710018 Pag. 15	COMTC710028 Pag. 22	COMTC710026 Pag. 23
HSK63F-LN	-	-	COMTC710006 Pag. 16	COMTC710015 Pag. 17	COMTC710005 Pag. 24	COMTC710027 Pag. 25

ACCESSORIES FOR ATC71 ELECTROSPINDLES	
CABLE SETS	Pag. 26
TOOLHOLDERS, COLLETS and NUTS	Pag. 27
FORKS and INVERTERS	Pag. 28

ATC71-A-ISO30-SN

ATC71-A TORQUE AND POWER CURVES

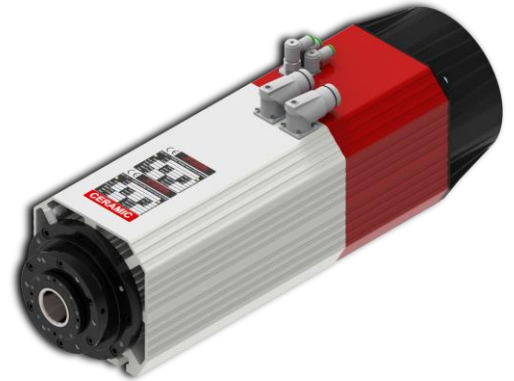
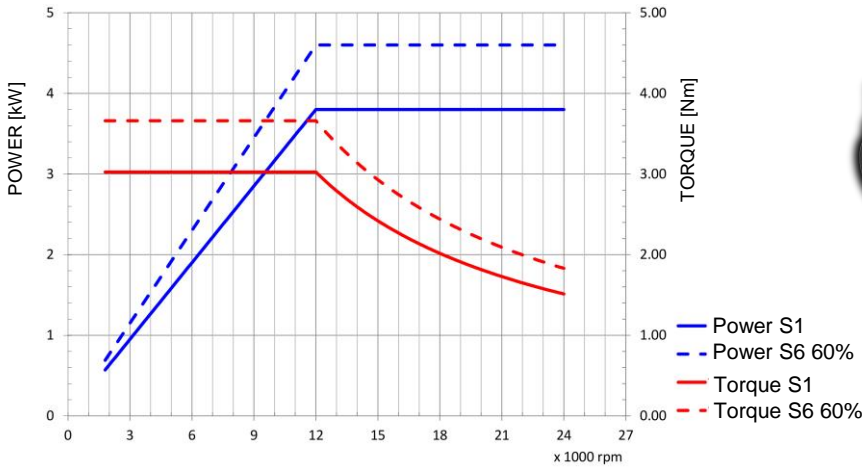

Motor code: **COMTC710001**

Power S1: 3.8 Kw (S1) @ 12000 rpm
 Power S6: 4.6 Kw (S6) @ 12000 rpm
 Voltage: 380V (option 220V)
 Poles: 2
 Max speed: 24000 rpm @ 400 Hz
 Bearings: Ceramic, front and rear

Tool-holder release 6 bar Ø8mm

Pressurization 6 bar Ø8mm (Automatic cone cleaning included)

Tool-holder hook-up 6 bar Ø8mm

Electric fan

ISO30 DIN69871 cone Taper 7/24

Teknomotor pull-stud

Pneumatic connector

Power connector

Signal connector

Use only nuts for T-slots. UNI 5531

Power [kW]	Duty Cycle	Base speed [rpm]	Base freq. [Hz]	Base voltage Δ [V]	Base voltage Y [V]	Protection	Ins. Cl.
3.8/4.6	S1/S6-60 %	12000	200	380	380	IP54	F
Min speed [rpm]	Max speed [rpm]	Max freq. [Hz]	Absorb. Δ [A]	Absorb. Y [A]	Part number on nameplate		
3000	24000	400	8.3/10.0	8.3/10.0	COMTC710001		
Balancing: G2.5 - ISO 1940 @ maximum motor speed	Balancing type	Foot type	Foot type	Foot type	Peso / weight		
		Ø 10	Ø 10	Ø 10	20.79 kg		

Power connector	
1	U
2	V
3	W
GND	Ground
A	Fan (L) 220V
B	Thermal protection
C	Thermal protection
D	Fan (N) 220V

Signal connector	
1	S1
2	S2
3	S3 tacho
4	not used
5	S5
6	0 V
7	+24V DC

rev. n°	description	date	signature
00	Emissione	05/08/2014	D. Bottarel

drawn - date	approved - date	checked - date	sostituisce il	folgio / sheet	scala	
D. Bottarel - 05/08/2014	S. Perli - 05/08/2014	S. Perli - 05/08/2014	sostituito dal	1 / 1	n.d.	

Tolerance non quotate / unlisted tolerances: ±0.5mm
 Smussi non quotati / unlisted chamfers: ±0.5mm

Titolo
ATC71-A-ISO30-SN

Customer
Catalogo

Drawing code
COMTC710001

Drawing n°
2673

TEKNO MOTOR

Teknomotor S.r.l.
 Via Agneraga 31, I-32038 Quero Vias (BL)
 www.teknomotor.com

Il presente disegno è di proprietà esclusiva di Teknomotor S.r.l. La riproduzione totale o parziale o la divulgazione a terzi, senza nostro esplicito consenso scritto, verrà perseguito secondo i termini di legge in vigore.

ATC71-A-ISO30-LN

ATC71-A TORQUE AND POWER CURVES

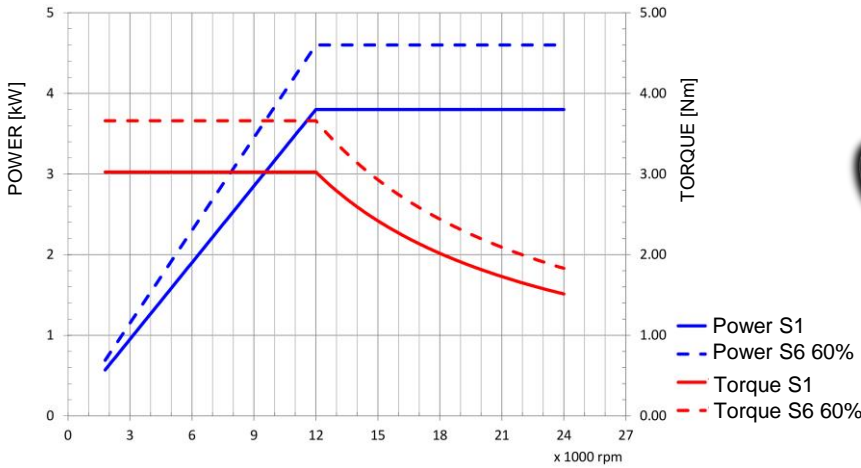

Motor code: **COMTC710007**

Power S1: 3.8 Kw (S1) @ 12000 rpm
 Power S6: 4.6 Kw (S6) @ 12000 rpm
 Voltage: 380V (option 220V)
 Poles: 2
 Max speed: 24000 rpm @ 400 Hz
 Bearings: Ceramic, front and rear

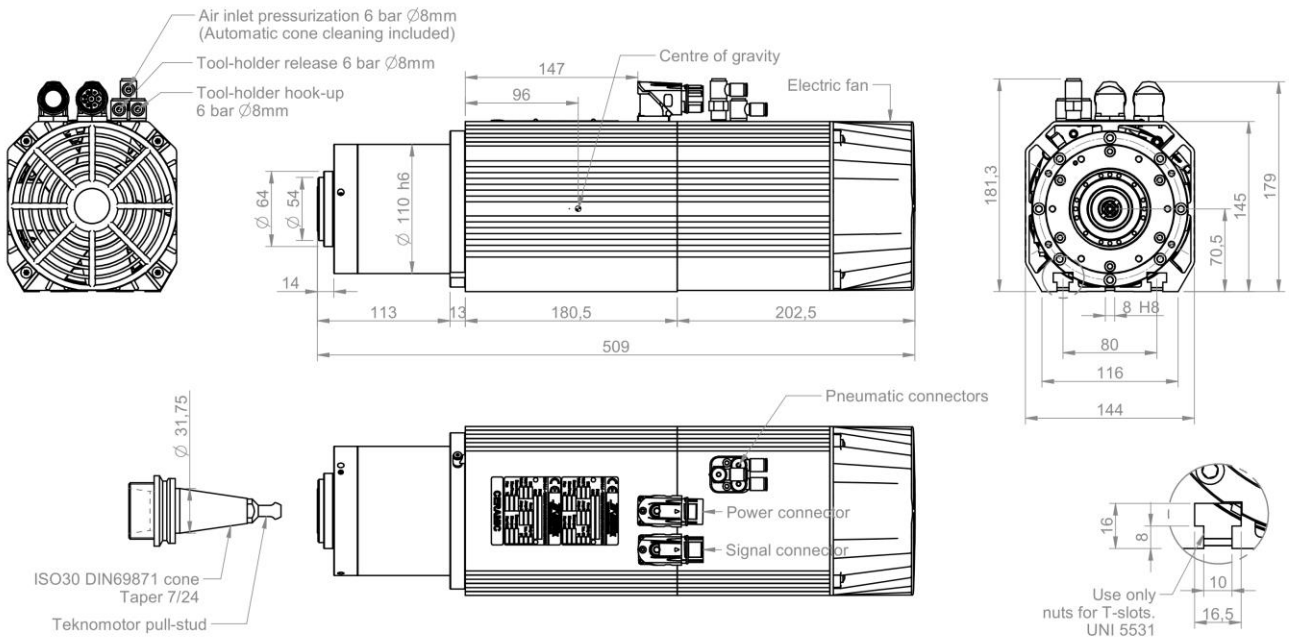

Power connector	
1	U
2	V
3	W
GND	Ground
A	Fan (L) 220V
B	Thermal protection
C	Thermal protection
D	Fan (N) 220V

Signal connector	
1	S1
2	S2
3	S3 tacho
4	not used
5	S5
6	0 V
7	+24V DC

Power [kW]	3.8/4.6	Duty Cycle	S1/S6-60 %	Base speed [rpm]	12000	Base freq. [Hz]	200	Base voltage Δ [V]	380	Base voltage Y [V]	380	Protection	IP54	Ins. Cl.	F						
Min speed [rpm]	3000	Max speed [rpm]	24000	Max freq. [Hz]	400	Absorb. Δ [A]	8.3/10.0	Absorb. Y [A]	8.3/10.0	Part number on nameplate	COMTC710007										
Balancing: G2.5 - ISO 1940 @ maximum motor speed				Balancing type				Foot type	Foot type	Peso / weight		26.34 kg									
Tolerance non quotata / unlisted tolerances: ±0.5mm Smussi non quotati / unlisted chamfers: +0.5mm												= 0.8 V = 3.2 V = 12 V = V		Title ATC71-A-ISO30-LN							
rev. n°	description							date	signature		Customer										
00	Emissione							03/09/2014	D. Bottarel		Catalogo										
drawn - date										approved - date		checked - date		sostituisce il		foglio / sheet		scala			
D. Bottarel - 03/09/2014										S. Perli - 03/09/2014		S. Perli - 03/09/2014		sostituito dal		1 / 1		1:4		A4	

ATC71-A-ISO30-LN

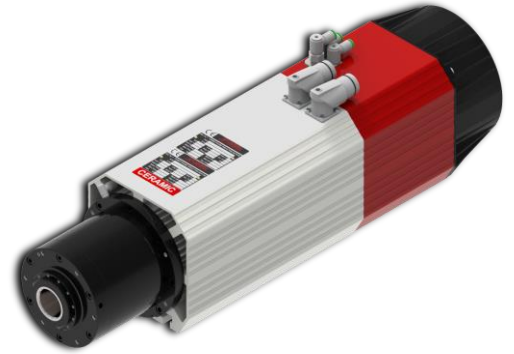

ATC71-A TORQUE AND POWER CURVES

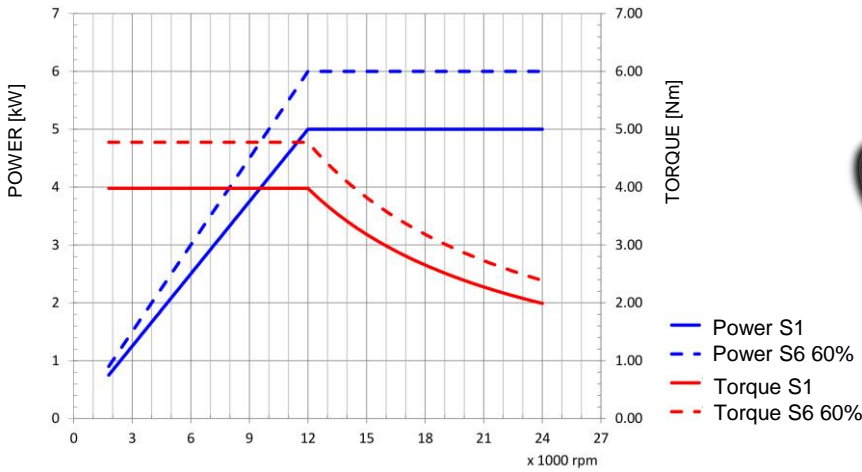

Motor code: **COMTC710021**

Power S1: 5.0 Kw (S1) @ 12000 rpm
 Power S6: 6.0 Kw (S6) @ 12000 rpm
 Voltage: 380V (option 220V)
 Poles: 4
 Max speed: 24000 rpm @ 800 Hz
 Bearings: Ceramic, front and rear

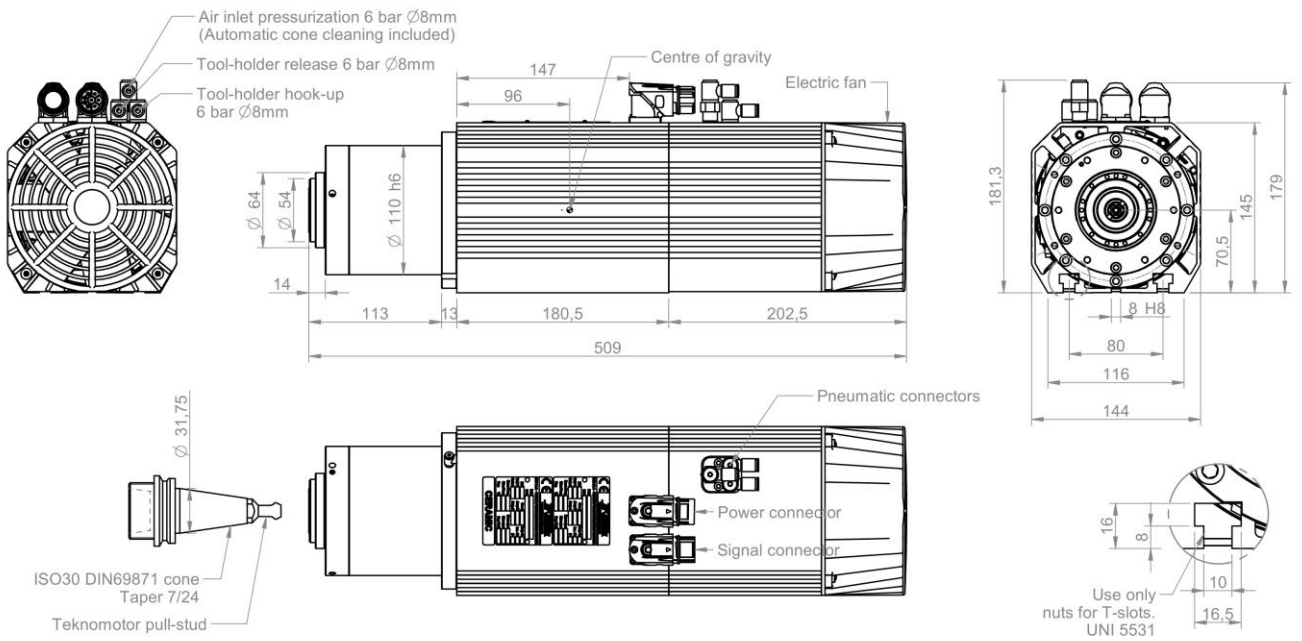

Power connector	
1	U
2	V
3	W
GND	Ground
A	Fan (L) 220V
B	Thermal protection
C	Thermal protection
D	Fan (N) 220V

Signal connector	
1	S1
2	S2
3	S3 tacho
4	not used
5	S5
6	0 V
7	+24V DC

Power [kW]	5.0/6.0	Duty Cycle	S1/S6-60 %	Base speed [rpm]	12000	Base freq. [Hz]	400	Base voltage Δ [V]	380	Base voltage Y [V]	12.0/14.0	Protection	IP54	Ins. Cl.	F				
Min speed [rpm]	3000	Max speed [rpm]	24000	Max freq. [Hz]	800	Absorb. Δ [A]		Absorb. Y [A]		Part number on nameplate COMTC710021									
Balancing: G2.5 - ISO 1940 @ maximum motor speed				Balancing type		Foot type		Foot type		Peso / weight 25.84 kg									
Tolerance non quotata / unlisted tolerances: ±0.5mm Smussi non quotati / unlisted chamfers: +0.5mm												Title		TEKNOMOTOR					
rev. n° / description												date		signature		Customer			
00 Emissione												26/01/2017		D. Bottarel		Catalogo			
drawn - date												approved - date		checked - date		sostituisce il		foglio / sheet	
D. Bottarel - 26/01/2017												S. Perli - 26/01/2017		S. Perli - 26/01/2017		sostituito dal		1 / 1	
D. Bottarel - 26/01/2017												S. Perli - 26/01/2017		S. Perli - 26/01/2017		Title		A4	
D. Bottarel - 26/01/2017												S. Perli - 26/01/2017		S. Perli - 26/01/2017		Title		A4	

Il presente disegno è di proprietà esclusiva di Teknomotor S.r.l. La riproduzione totale o parziale o la divulgazione a terzi, senza nostro esplicito consenso scritto, verrà perseguito secondo i termini di legge in vigore.

ATC71-B-ISO30-SN

ATC71-B TORQUE AND POWER CURVES

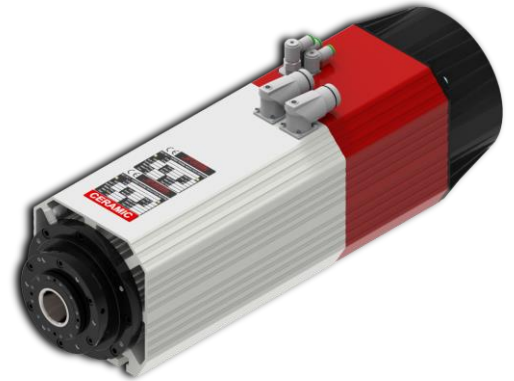
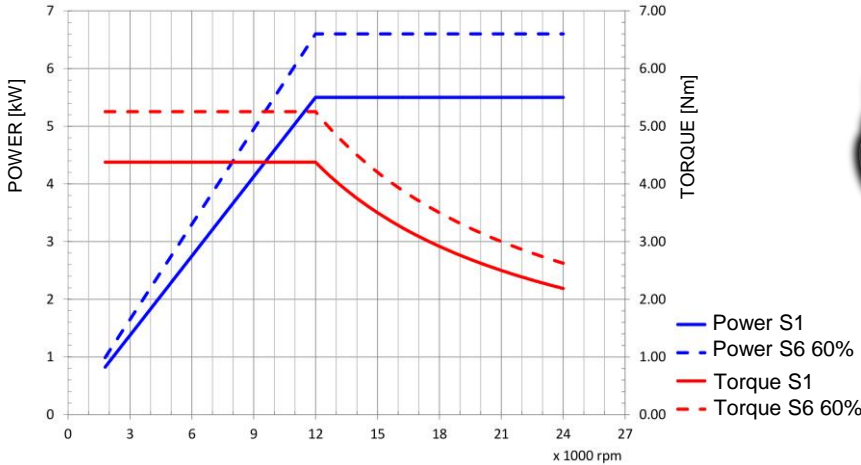

Motor code: **COMTC710004**

Power S1: 5.5 Kw (S1) @ 12000 rpm
 Power S6: 6.6 Kw (S6) @ 12000 rpm
 Voltage: 380V (option 220V)
 Poles: 2
 Max speed: 24000 rpm @ 400 Hz
 Bearings: Ceramic, front and rear

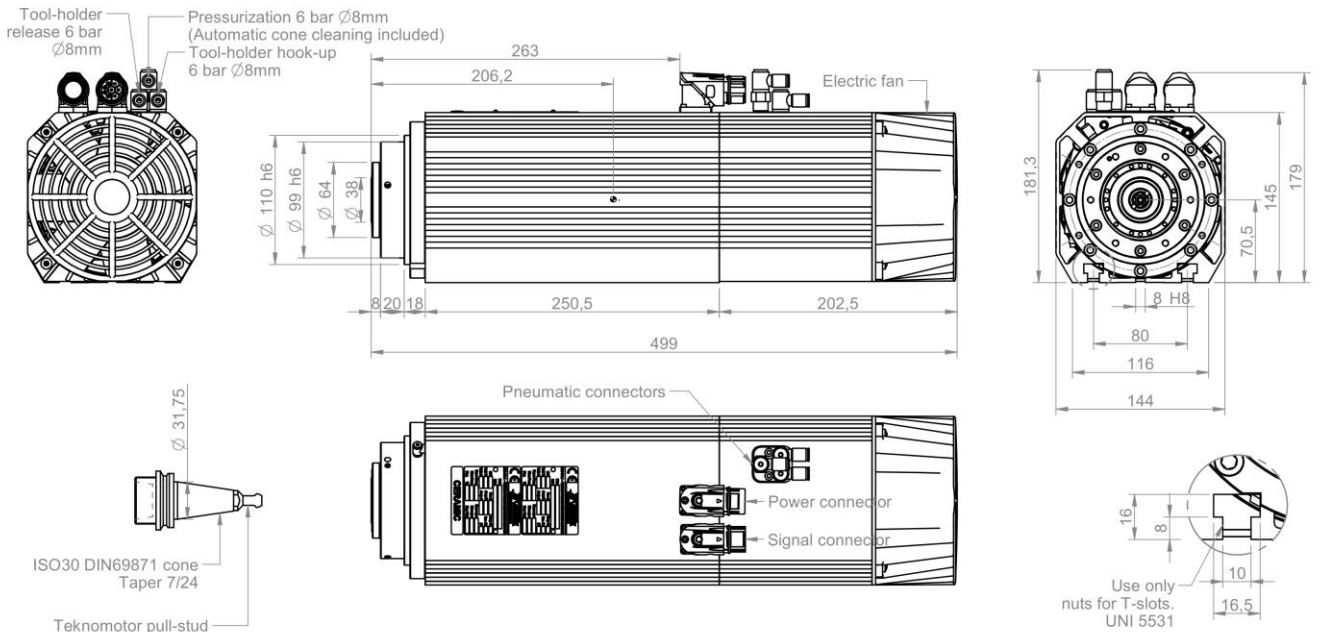

Power connector	
1	U
2	V
3	W
GND	Ground
A	Fan (L) 220V
B	Thermal protection
C	Thermal protection
D	Fan (N) 220V

Signal connector	
1	S1
2	S2
3	S3 tacho
4	not used
5	S5
6	0 V
7	+24V DC

Power [kW]	Duty Cycle	Base speed [rpm]	Base freq. [Hz]	Base voltage Δ [V]	Base voltage Y [V]	Protection	Ins. Cl.
5.5/6.6	S1/S6-60 %	12000	200	380	380	IP54	F
Min speed [rpm]	Max speed [rpm]	Max freq. [Hz]	Absorb. Δ [A]	Absorb. Y [A]	Part number on nameplate		
3000	24000	400	11.4/13.4	11.4/13.4	COMTC710004		
Balancing: G2.5 - ISO 1940 @ maximum motor speed	Balancing type	Foot type	Foot type	Foot type	Peso / weight		
		full key	full key	full key	24.83 kg		
Tolerance non quotata / unlisted tolerances: ±0.5mm Smussi non quotati / unlisted chamfers: +0.5mm							
rev. n°	description	date	signature	Title			
00	Emissione	05/09/2014	D. Bottarel	ATC71-B-ISO30-SN			
Customer				Drawing code			
				COMTC710004			
D. Bottarel - 05/09/2014				S. Peris - 05/09/2014			
checked - date				Sostituisce il			
				Sostituito dal			
foglio / sheet				scala			
1 / 1				1:4			
A4							

ATC71-B-ISO30-SN



ATC71-B TORQUE AND POWER CURVES

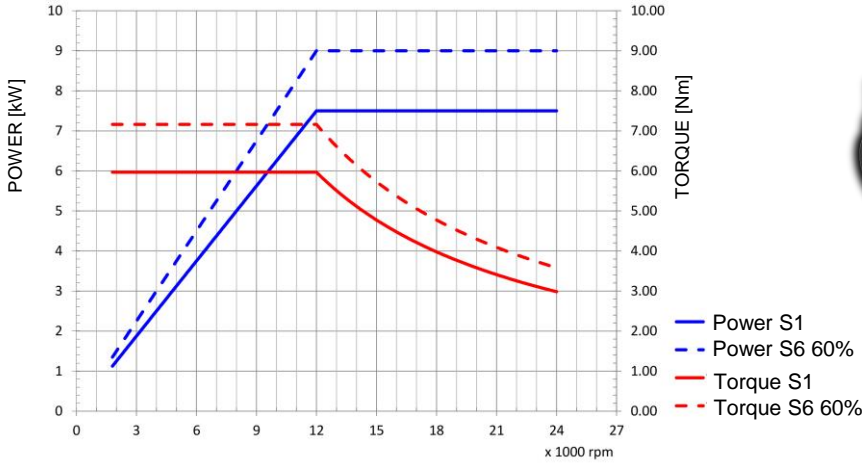

Motor code: **COMTC710022**

Power S1: 7.5 Kw (S1) @ 12000 rpm
 Power S6: 9.0 Kw (S6) @ 12000 rpm
 Voltage: 380V (option 220V)
 Poles: 4
 Max speed: 24000 rpm @ 800 Hz
 Bearings: Ceramic, front and rear

Tool-holder release 6 bar Ø8mm
 Pressurization 6 bar Ø8mm (Automatic cone cleaning included)
 Tool-holder hook-up 6 bar Ø8mm

263
208,3
8,20 18
250,5
202,5
499
Electric fan

ISO30 DIN69871 cone
Taper 7/24
Teknomotor pull-stud

181,3
179
145
70,5
8 H8
80
116
144

Use only nuts for T-slots.
UNI 5531

Pneumatic connectors
Power connector
Signal connector

Ø 31,75

Power [kW]	Duty Cycle	Base speed [rpm]	Base freq. [Hz]	Base voltage Δ [V]	Base voltage Y [V]	Protection	Ins. Cl.
7.5/9.0	S1/S6-60 %	12000	400	380	380	IP54	F
Min speed [rpm]		Max speed [rpm]	Max freq. [Hz]	Absorb. Δ [A]	Absorb. Y [A]	Part number on nameplate	
3000		24000	800	15.7/19.0	15.7/19.0	COMTC710022	
Balancing: G2.5 - ISO 1940 @ maximum motor speed			Balancing type	Foot type	Foot type	Peso / weight	
				Full key	Half key	25.13 kg	
Tolerance non quotata / unlisted tolerances: ±0.5mm Smussi non quotati / unlisted chamfers: +0.5mm							
rev. n°				date		signature	
00				26/01/2017		D. Bottarel	
Description							
Emissione							
drawn - date		approved - date		checked - date		sostituisce il	
D. Bottarel - 26/01/2017		S. Peris - 26/01/2017		S. Peris - 26/01/2017		sostituito dal	
Title				Customer			
ATC71-B-ISO30-SN-4P				Catalogo			
Drawing code				Drawing n°			
COMTC710022				5055			
foglio / sheet		scala		A4			
1 / 1		1:4					

ATC71-B-ISO30-LN

ATC71-B TORQUE AND POWER CURVES

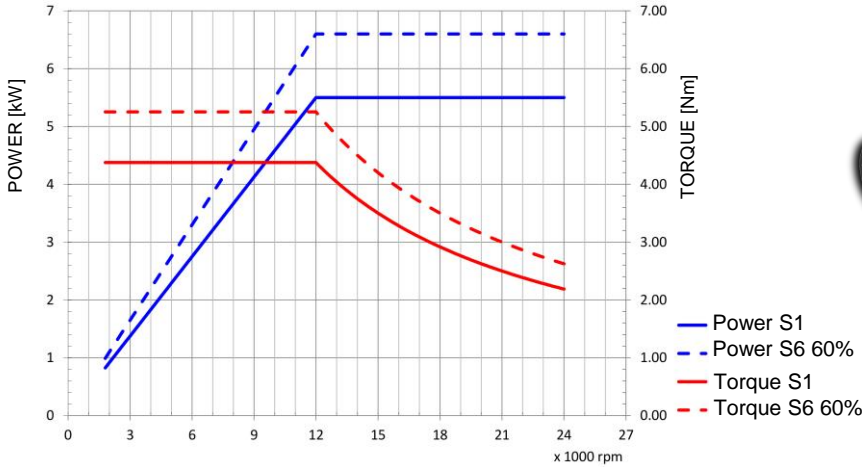

Motor code: **COMTC710008**

Power S1: 5.5 Kw (S1) @ 12000 rpm
 Power S6: 6.6 Kw (S6) @ 12000 rpm
 Voltage: 380V (option 220V)
 Poles: 2
 Max speed: 24000 rpm @ 400 Hz
 Bearings: Ceramic, front and rear

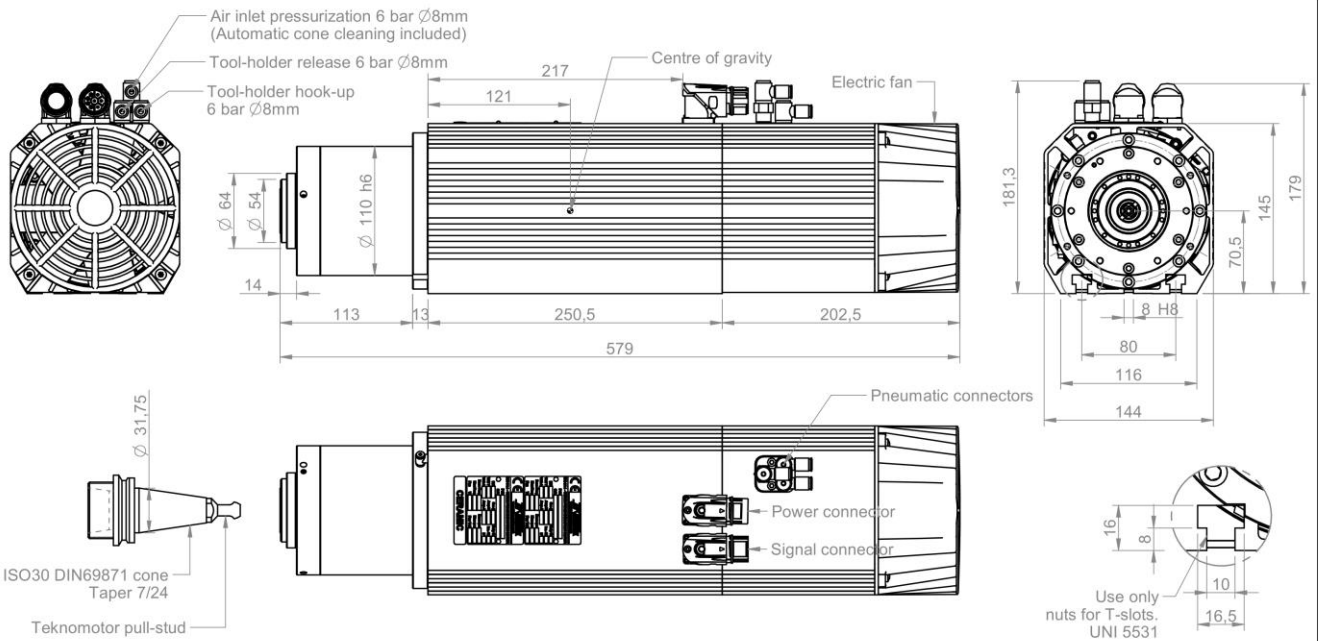

Power [kW]	Duty Cycle	Base speed [rpm]	Base freq. [Hz]	Base voltage Δ [V]	Base voltage Y [V]	Protection	Ins. Cl.
5.5/6.6	S1/S6-60%	12000	200	380	380	IP54	F
Min speed [rpm]	Max speed [rpm]	Max freq. [Hz]	Absorb. Δ [A]	Absorb. Y [A]	Part number on nameplate		
3000	24000	400	11.4/13.4	11.4/13.4	COMTC710008		
Balancing: G2.5 - ISO 1940 @ maximum motor speed		Balancing type	Foot type	Foot type	Peso / weight		
			full key	full key	30.36 kg		
Tolerance non quotati / unlisted tolerances: \pm 0.5mm Smussi non quotati / unlisted chamfers: \pm 0.5mm							
rev. n°		description		date	signature		
00		Emissione		05/09/2014	D. Bottarel		
drawn - date				approved - date	checked - date	sostituisce il	
D. Bottarel - 05/09/2014				S. Peris - 05/09/2014	S. Peris - 05/09/2014	sostituito dal	
Title				Customer			
ATC71-B-ISO30-LN				Catalogo			
Drawing code				Drawing n°			
COMTC710008				3295			
foglio / sheet		scala		A4			
1 / 1		1:4					

ATC71-B-ISO30-LN

ATC71-B TORQUE AND POWER CURVES

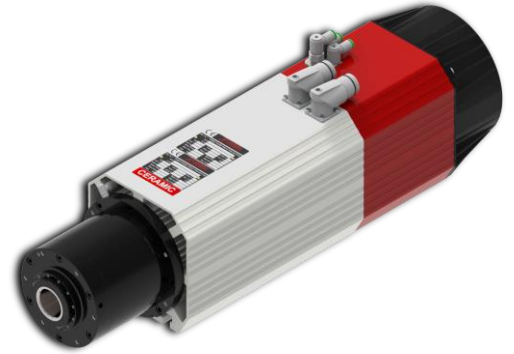
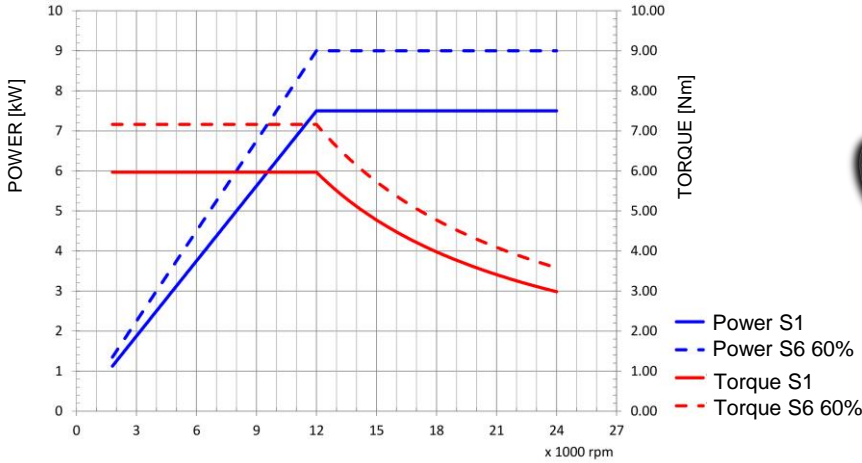

Motor code: **COMTC710014**

Power S1: 7.5 Kw (S1) @ 12000 rpm
 Power S6: 9.0 Kw (S6) @ 12000 rpm
 Voltage: 380V (option 220V)
 Poles: 4
 Max speed: 24000 rpm @ 800 Hz
 Bearings: Ceramic, front and rear

Technical drawing showing dimensions and features:
 Air inlet pressurization 6 bar Ø8mm (Automatic cone cleaning included)
 Tool-holder release 6 bar Ø8mm
 Tool-holder hook-up 6 bar Ø8mm
 Centre of gravity
 Electric fan
 Pneumatic connectors
 Power connector
 Signal connector
 ISO30 DIN69871 cone Taper 7/24
 Teknomotor pull-stud
 Use only nuts for T-slots, UNI 5531

Technical drawing showing dimensions and features:
 ISO30 DIN69871 cone Taper 7/24
 Teknomotor pull-stud
 Use only nuts for T-slots, UNI 5531

Power [kW]	Duty Cycle	Base speed [rpm]	Base freq. [Hz]	Base voltage Δ [V]	Base voltage Y [V]	Protection	Ins. Cl.
7.5/9.0	S1/S6-60 %	12000	400	380	380	IP54	F
Min speed [rpm]	Max speed [rpm]	Max freq. [Hz]	Absorb. Δ [A]	Absorb. Y [A]	Part number on nameplate		
3000	24000	800	15.7/19.0	15.7/19.0	COMTC710014		
Balancing: G2.5 - ISO 1940 @ maximum motor speed		Balancing type	Foot type	Foot type	Peso / weight		
			full key	full key	30.66 kg		
Tolerance non quotata / unlisted tolerances: ±0.5mm Smussi non quotati / unlisted chamfers: +0.5mm							
rev. n°				date		signature	
00				09/09/2016		D. Bottarel	
description				Emissione		Customer	
						Catalogo	
drawn - date				approved - date		checked - date	
D. Bottarel - 09/09/2016		S. Peris - 09/09/2016		S. Peris - 09/09/2016		sostituisce il	
				sostituito dal		foglio / sheet	
						1 / 1	
						scala	
						1:4	
						A4	

ATC71-B-HSK63F-SN

ATC71-B TORQUE AND POWER CURVES

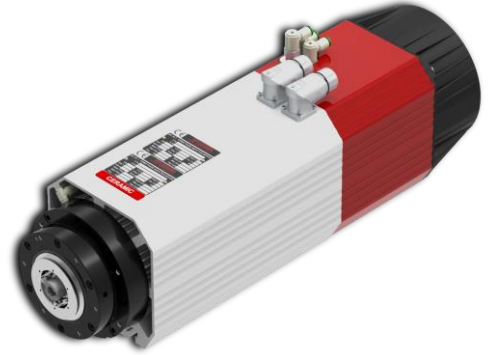
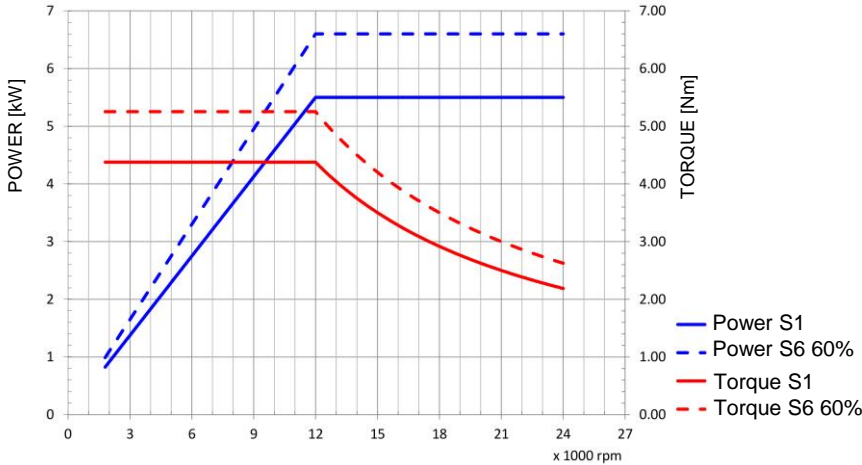

Motor code: **COMTC710023**

Power S1: 5.5 Kw (S1) @ 12000 rpm
 Power S6: 6.6 Kw (S6) @ 12000 rpm
 Voltage: 380V (option 220V)
 Poles: 2
 Max speed: 24000 rpm @ 400 Hz
 Bearings: Ceramic, front and rear

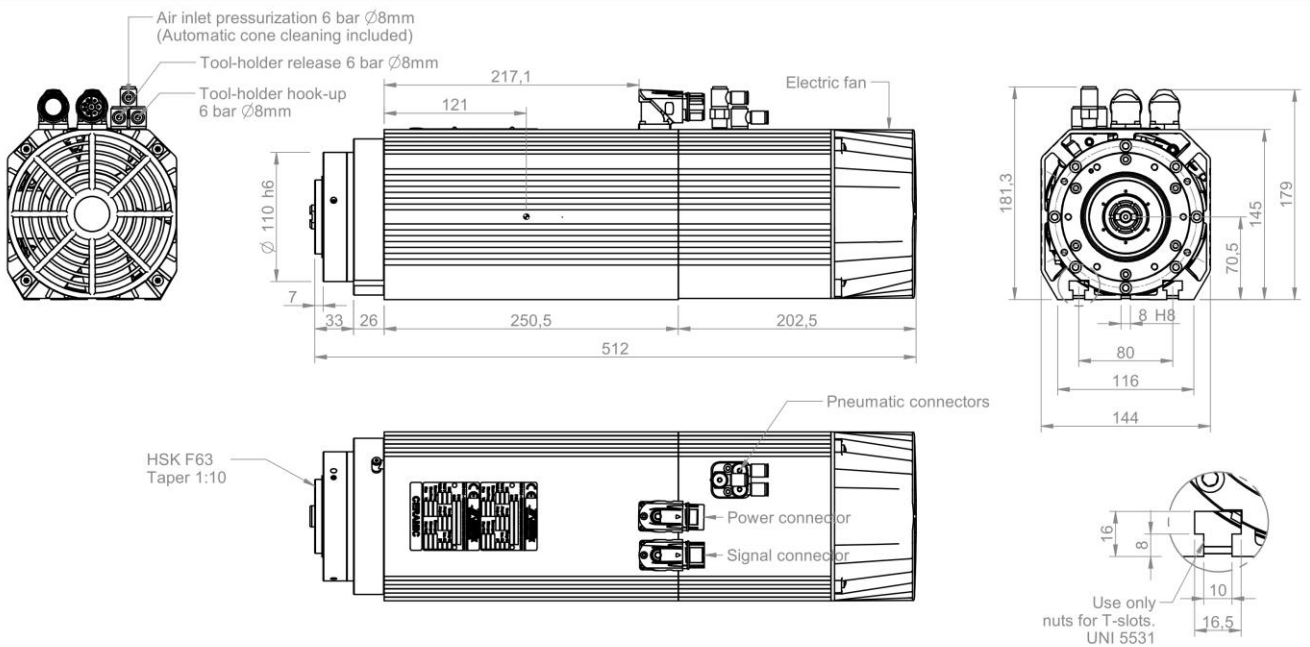

Power connector	
1	U
2	V
3	W
GND	Ground
A	Fan (L) 220V
B	Thermal protection
C	Thermal protection
D	Fan (N) 220V

Signal connector	
1	S1
2	S2
3	S3 tacho
4	S4
5	S5
6	0 V
7	+24V DC

Power [kW] 5.5/6.6	Duty Cycle S1/S6-60 %	Base speed [rpm] 12000	Base freq. [Hz] 200	Base voltage Δ [V] 380	Protection IP54	Ins. Cl. F
Min speed [rpm] 3000	Max speed [rpm] 24000	Max freq. [Hz] 400	Absorb. Δ [A] 11.4/13.4	Absorb. Y [A] COMTC710023	Part number on nameplate COMTC710023	
Balancing: G2.5 - ISO 1940 @ maximum motor speed		Balancing type	Foot type full key	Foot type full key	Peso / weight 26.50 kg	
Tolerance non quotati / unlisted tolerances: ±0.5mm Smussi non quotati / unlisted chamfers: +0.5mm			vv = 0.8 √	vw = 3.2 √	v = 12.5 √	- = √
rev. n° 00	description Emissione		date 01/02/2017	signature D. Bottarel		
drawn - date D. Bottarel - 01/02/2017			approved - date S. Peris - 01/02/2017	checked - date S. Peris - 01/02/2017	sostituisce il sostituito dal	
Title ATC71-B-HSK63F-SN				Customer Catalogo		
Drawing code COMTC710023				Drawing n° 5063		
foglio / sheet 1 / 1		scala 1:4		A4		

ATC71-B-HSK63F-SN

ATC71-B TORQUE AND POWER CURVES

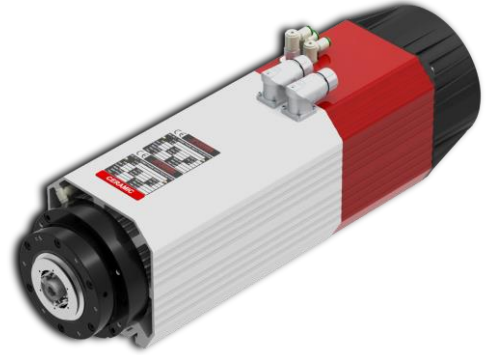
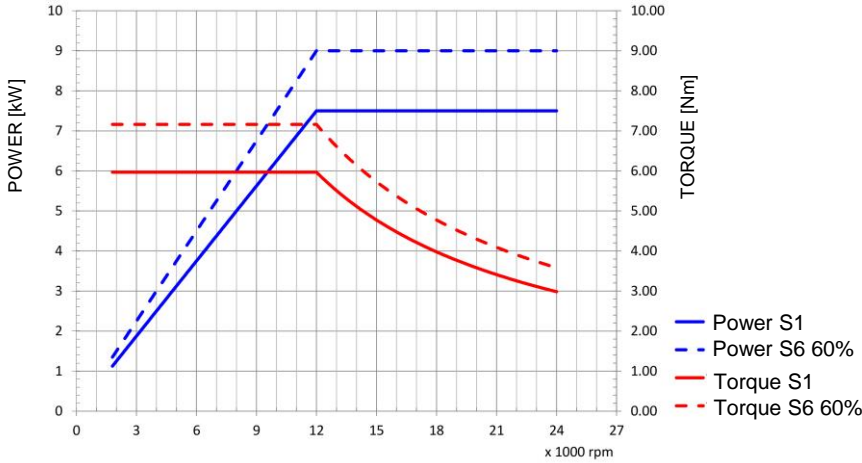

Motor code: **COMTC710018**

Power S1: 7.5 Kw (S1) @ 12000 rpm
 Power S6: 9.0 Kw (S6) @ 12000 rpm
 Voltage: 380V (option 220V)
 Poles: 4
 Max speed: 24000 rpm @ 800 Hz
 Bearings: Ceramic, front and rear

Air inlet pressurization 6 bar Ø8mm (Automatic cone cleaning included)

Tool-holder release 6 bar Ø8mm

Tool-holder hook-up 6 bar Ø8mm

Electric fan

HSK F63 Taper 1:10

Pneumatic connectors

Power connector

Signal connector

Dimensions: 181.3, 179, 145, 70.5, 8, 8 H8, 80, 116, 144, 16, 8, 10, 16.5

Use only nuts for T-slots. UNI 5531

Power [kW]	Duty Cycle	Base speed [rpm]	Base freq. [Hz]	Base voltage Δ [V]	Base voltage Y [V]	Protection	Ins. Cl.
7.5/9.0	S1/S6-60 %	12000	400	380	380	IP54	F
Min speed [rpm]	Max speed [rpm]	Max freq. [Hz]	Absorb. Δ [A]	Absorb. Y [A]	Part number on nameplate		
3000	24000	800	15.7/19.0	15.7/19.0	COMTC710018		
Balancing: G2.5 - ISO 1940 @ maximum motor speed		Balancing type	Foot type	Foot type	Peso / weight		
			⊕	⊕	26.80 kg		
Tolerance non quotati / unlisted tolerances: ±0.5mm Smussi non quotati / unlisted chamfers: +0.5mm							
rev. n°	description			date	signature	Title	
00	Emissione			12/10/2016	D. Bottarel	ATC71-B-HSK63F-SN-4P	
Customer						Catalogo	
Drawing code						COMTC710018	
Drawing n°						5059	
drawn - date	approved - date	checked - date	sostituisce il	foglio / sheet		scala	A4
D. Bottarel - 12/10/2016	S. Perli - 12/10/2016	S. Perli - 12/10/2016	sostituito dal	1 / 1		1:4	

ATC71-B-HSK63F-LN

ATC71-B TORQUE AND POWER CURVES

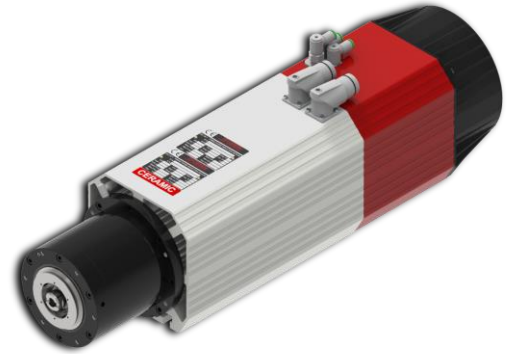
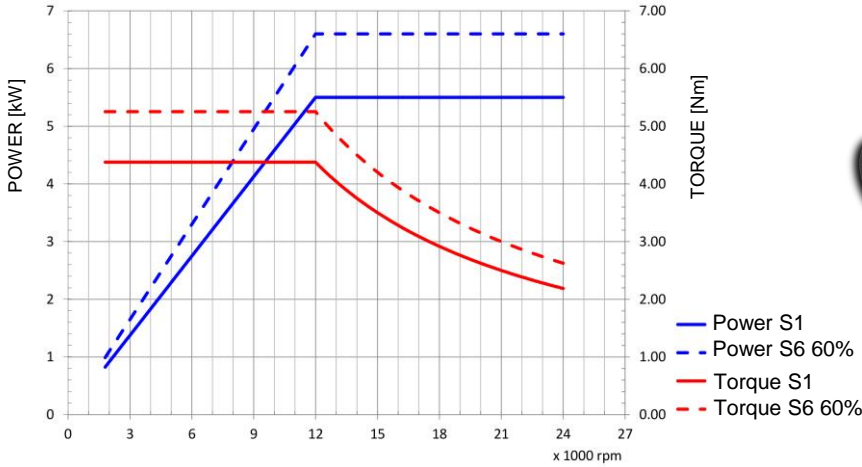

Motor code: **COMTC710006**

Power S1: 5.5 Kw (S1) @ 12000 rpm
 Power S6: 6.6 Kw (S6) @ 12000 rpm
 Voltage: 380V (option 220V)
 Poles: 2
 Max speed: 24000 rpm @ 400 Hz
 Bearings: Ceramic, front and rear

Air inlet pressurization 6 bar Ø8mm (Automatic cone cleaning included)
 Tool-holder release 6 bar Ø8mm
 Tool-holder hook-up 6 bar Ø8mm
 Electric fan
 Pneumatic connectors
 HSK F63 Taper 1:10
 Power connector
 Signal connector

181,3
 179
 145
 70,5
 8 H8
 80
 116
 144
 16
 8
 10
 16,5
 Use only nuts for T-slots. UNI 5531

Power [kW]	5.5/6.6	Duty Cycle	S1/S6-60 %	Base speed [rpm]	12000	Base freq. [Hz]	200	Base voltage Δ [V]	380	Protection	IP54	Ins. Cl.	F
Min speed [rpm]	3000	Max speed [rpm]	24000	Max freq. [Hz]	400	Absorb. Δ [A]	11.4/13.4	Absorb. Y [A]	11.4/13.4	Part number on nameplate	COMTC710006		
Balancing: G2.5 - ISO 1940 @ maximum motor speed				Balancing type				Foot type	Foot type	Peso / weight		30.45 kg	
Tolerance non quotati / unlisted tolerances: ±0.5mm Smussi non quotati / unlisted chamfers: +0.5mm												$\nabla = 0.8 \sqrt{\quad}$ $\nabla = 3.2 \sqrt{\quad}$ $\nabla = 12.5 \sqrt{\quad}$ $\nabla = \sqrt{\quad}$	
rev. n°	00	description		Emissione		date	05/09/2014	signature	D. Bottarel		Title		ATC71-B-HSK63F-LN
Customer										Catalogo			
Drawing code										COMTC710006			
Drawing n°										3292			
drawn - date	D. Bottarel - 05/09/2014	approved - date	S. Perri - 05/09/2014	checked - date	S. Perri - 05/09/2014	sostituisce il		sostituito dal		folgio / sheet	1 / 1	scala	1:4
Il presente disegno è di proprietà esclusiva di Teknomotor S.r.l. La riproduzione totale o parziale o la divulgazione a terzi, senza nostro esplicito consenso scritto, verrà perseguita secondo i termini di legge in vigore.													

Power connector	
1	U
2	V
3	W
GND	Ground
A	Fan (L) 220V
B	Thermal protection
C	Thermal protection
D	Fan (N) 220V

Signal connector	
1	S1
2	S2
3	S3 tacho
4	S4
5	S5
6	0 V
7	+24V DC

ATC71-B-HSK63F-LN

ATC71-B TORQUE AND POWER CURVES

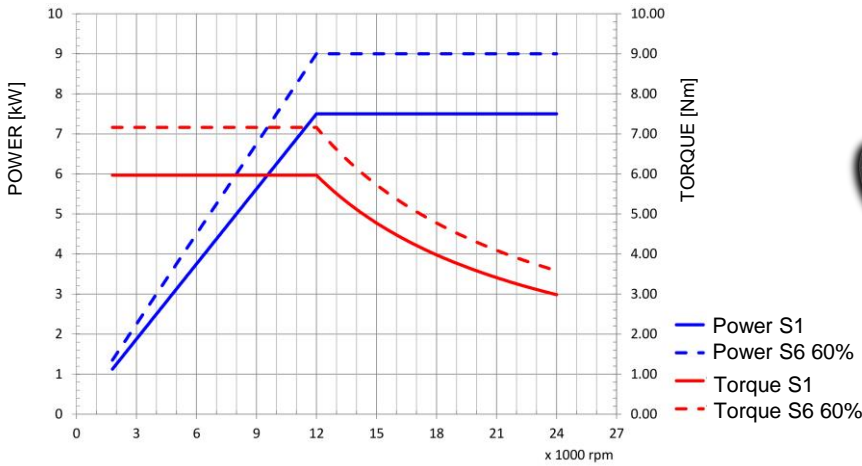

Motor code: **COMTC710015**

Power S1: 7.5 Kw (S1) @ 12000 rpm
 Power S6: 9.0 Kw (S6) @ 12000 rpm
 Voltage: 380V (option 220V)
 Poles: 4
 Max speed: 24000 rpm @ 800 Hz
 Bearings: Ceramic, front and rear

Air inlet pressurization 6 bar Ø8mm (Automatic cone cleaning included)
 Tool-holder release 6 bar Ø8mm
 Tool-holder hook-up 6 bar Ø8mm
 Electric fan
 HSK F63 Taper 1:10
 Pneumatic connectors
 Power connector
 Signal connector

Dimensions: 181.3, 179, 145, 70.5, 80, 116, 144, 8 H8, 16, 8, 10, 16.5

Use only nuts for T-slots. UNI 5531

Power [kW]	Duty Cycle	Base speed [rpm]	Base freq. [Hz]	Base voltage Δ [V]	Base voltage Y [V]	Protection	Ins. Cl.
7.5/9.0	S1/S6-60 %	12000	400	380	380	IP54	F
Min speed [rpm]	Max speed [rpm]	Max freq. [Hz]	Absorb. Δ [A]	Absorb. Y [A]	Part number on nameplate		
3000	24000	800	15.7/19.0	15.7/19.0	COMTC710015		
Balancing: G2.5 - ISO 1940 @ maximum motor speed		Balancing type	Foot type	Foot type	Peso / weight		
			full key	full key	30.76 kg		
Tolerance non quotati / unlisted tolerances: ±0.5mm Smussi non quotati / unlisted chamfers: +0.5mm							
rev. n°		description		date		signature	
00		Emissione		15/09/2016		D. Bottarel	
drawn - date				approved - date		checked - date	
D. Bottarel - 15/09/2016		S. Perli - 15/09/2016		S. Perli - 15/09/2016		sostituisce il	
				sostituito dal		foglio / sheet	
						1 / 1	
						scala	
						1:4	
						A4	

Power connector	
1	U
2	V
3	W
GND	Ground
A	Fan (L) 220V
B	Thermal protection
C	Thermal protection
D	Fan (N) 220V

Signal connector	
1	S1
2	S2
3	S3 tacho
4	S4
5	S5
6	0 V
7	+24V DC

TEKnomotor
 Teknomotor S.r.l.
 Via Argemone 31, I-32038 Quero Vias (BL)
 www.teknomotor.com

Title	
ATC71-B-HSK63F-LN-4P	
Customer	Catalogo
Drawing code	COMTC710015
Drawing n°	3291

folgio / sheet	1 / 1
scala	1:4

ATC71-C-ISO30-SN

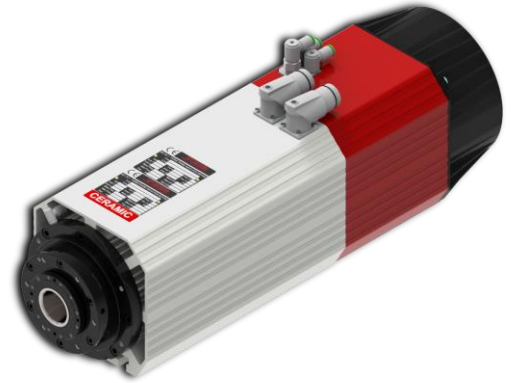

ATC71-C TORQUE AND POWER CURVES

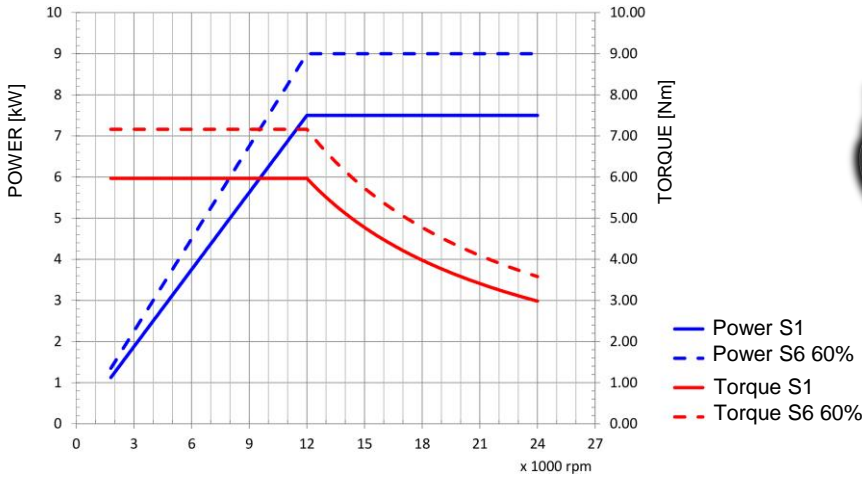

Motor code: **COMTC710003**

Power S1: 7.5 Kw (S1) @ 12000 rpm
 Power S6: 9.0 Kw (S6) @ 12000 rpm
 Voltage: 380V (option 220V)
 Poles: 2
 Max speed: 24000 rpm @ 400 Hz
 Bearings: Ceramic, front and rear

Tool-holder release 6 bar Ø8mm

Pressurization 6 bar Ø8mm (Automatic cone cleaning included)

Tool-holder hook-up 6 bar Ø8mm

263

208,3

8 20 18

250,5

202,5

499

Electric fan

181,3

179

145

70,5

8 H8

80

116

144

ISO30 DIN69871 cone Taper 7/24

Teknomotor pull-stud

Ø 31,75

Pneumatic connectors

Power connector

Signal connector

Use only nuts for T-slots. UNI 5531

16

10

16,5

Power [kW]	Duty Cycle	Base speed [rpm]	Base freq. [Hz]	Base voltage Δ [V]	Base voltage Y [V]	Protection	Ins. Cl.
7.5/9.0	S1/S6-60 %	12000	200	380	380	IP54	F
Min speed [rpm]		Max speed [rpm]	Max freq. [Hz]	Absorb. Δ [A]	Absorb. Y [A]	Part number on nameplate	
3000		24000	400	16.0/19.2	16.0/19.2	COMTC710003	
Balancing: G2.5 - ISO 1940 @ maximum motor speed		Balancing type		Foot type	Foot key	Peso / weight	
				Foot type	Foot key	26.47 kg	
Tolerance non quotata / unlisted tolerances: ±0.5mm Smussi non quotati / unlisted chamfers: +0.5mm							
rev. n°	description			date	signature	Title	
00	Emissione			05/09/2014	D. Bottarel	ATC71-C-ISO30-SN	
Customer						Catalogo	
Drawing code						COMTC710003	
Drawing n°						2675	
drawn - date	approved - date	checked - date	sostituisce il	foglio / sheet		scala	A4
D. Bottarel - 05/09/2014	S. Peri - 05/09/2014	S. Peri - 05/09/2014	sostituito dal	1 / 1		1:4	

ATC71-C-ISO30-SN

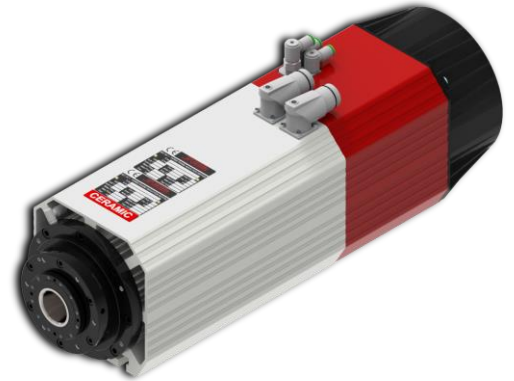

ATC71-C TORQUE AND POWER CURVES

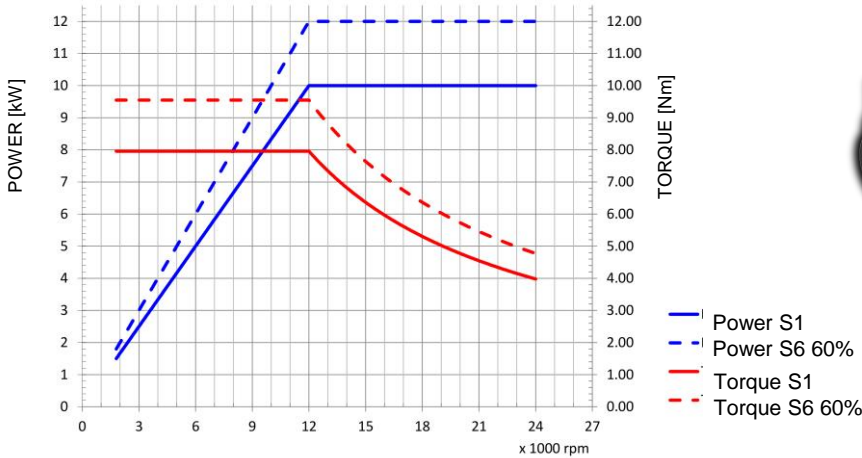

Motor code: **COMTC710024**

Power S1: 10.0 Kw (S1) @ 12000 rpm
 Power S6: 12.0 Kw (S6) @ 12000 rpm
 Voltage: 380V (option 220V)
 Poles: 4
 Max speed: 24000 rpm @ 800 Hz
 Bearings: Ceramic, front and rear

Tool-holder release 6 bar Ø8mm

Pressurization 6 bar Ø8mm (Automatic cone cleaning included)

Tool-holder hook-up 6 bar Ø8mm

Electric fan

ISO30 DIN69871 cone Taper 7/24

Teknomotor pull-stud

Pneumatic connectors

Power connector

Signal connector

Use only nuts for T-slots. UNI 5531

Power [kW]	Duty Cycle	Base speed [rpm]	Base freq. [Hz]	Base voltage Δ [V]	Base voltage Y [V]	Protection	Ins. Cl.
10.0/12.0	S1/S6-60 %	12000	400	380	380	IP54	F
Min speed [rpm]	Max speed [rpm]	Max freq. [Hz]	Absorb. Δ [A]	Absorb. Y [A]	Part number on nameplate		
3000	24000	800		20.0/24.0	COMTC710024		
Balancing: G2.5 - ISO 1940 @ maximum motor speed	Balancing type	Foot type	Foot type	Foot type	Peso / weight		
		full key	full key	full key	25.13 kg		

Power connector	
1	U
2	V
3	W
GND	Ground
A	Fan (L) 220V
B	Thermal protection
C	Thermal protection
D	Fan (N) 220V

Signal connector	
1	S1
2	S2
3	S3 tacho
4	not used
5	S5
6	0 V
7	+24V DC

Tolerance non quotata / unlisted tolerances: ±0.5mm Smussi non quotati / unlisted chamfers: ±0.5mm		Title	
00		ATC71-C-ISO30-SN-4P	
Description		Customer	
Emissione		Catalogo	
Drawing code		COMTC710024	
Drawing n°		5064	
drawn - date	approved - date	checked - date	substituisce il
D. Bottarel - 01/02/2017	S. Peris - 01/02/2017	S. Peris - 01/02/2017	substituisce dal
foglio / sheet		scala	
1 / 1		1:4	

ATC71-C-ISO30-LN



ATC71-C TORQUE AND POWER CURVES

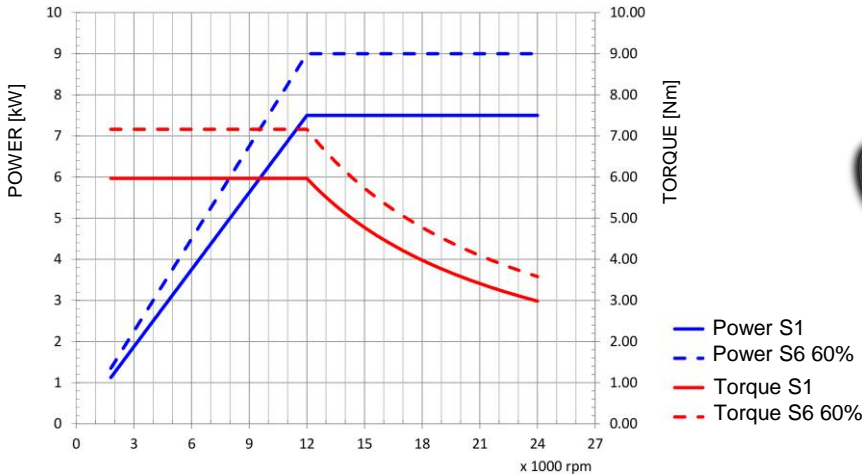

Motor code: **COMTC710009**

Power S1: 7.5 Kw (S1) @ 12000 rpm
 Power S6: 9.0 Kw (S6) @ 12000 rpm
 Voltage: 380V (option 220V)
 Poles: 2
 Max speed: 24000 rpm @ 400 Hz
 Bearings: Ceramic, front and rear

Use only nuts for T-slots. UNI 5531

Power [kW]	Duty Cycle	Base speed [rpm]	Base freq. [Hz]	Base voltage Δ [V]	380	Protection	IP54	Ins. Cl.	F
7.5/9.0	S1/S6-60 %	12000	200	Base voltage Y [V]	16.0/19.2	Part number on nameplate	COMTC710009		
Min speed [rpm]	3000	Max speed [rpm]	24000	Absorb. Δ [A]		Absorb. Y [A]			
Max speed [rpm]	3000	Max speed [rpm]	24000	Max freq. [Hz]	400	Peso / weight	32.00 kg		
Balancing: G2.5 - ISO 1940 @ maximum motor speed		Balancing type		Foot type	full key	Foot type	full key		
Tolerance non quotata / unlisted tolerances: ±0.5mm Smussi non quotati / unlisted chamfers: +0.5mm									
rev. n°	00	description	Emissione		date	05/09/2014	signature	D. Bottarel	
drawn - date	D. Bottarel - 05/09/2014	approved - date	S. Perli - 05/09/2014	checked - date	S. Perli - 05/09/2014	sostituisce il		sostituito dal	
Title						ATC71-C-ISO30-LN			
Customer						Catalogo			
Drawing code						COMTC710009		Drawing n°	
						3296			
foglio / sheet				1 / 1		scala		1:4	
A4									

ATC71-C-ISO30-LN

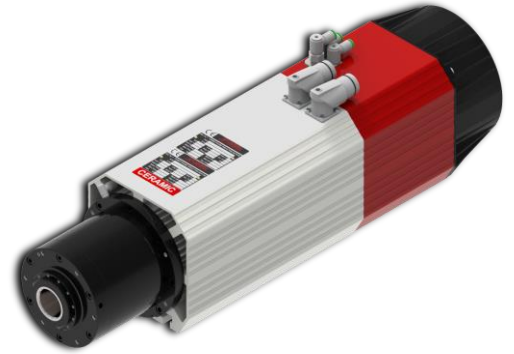

ATC71-C TORQUE AND POWER CURVES

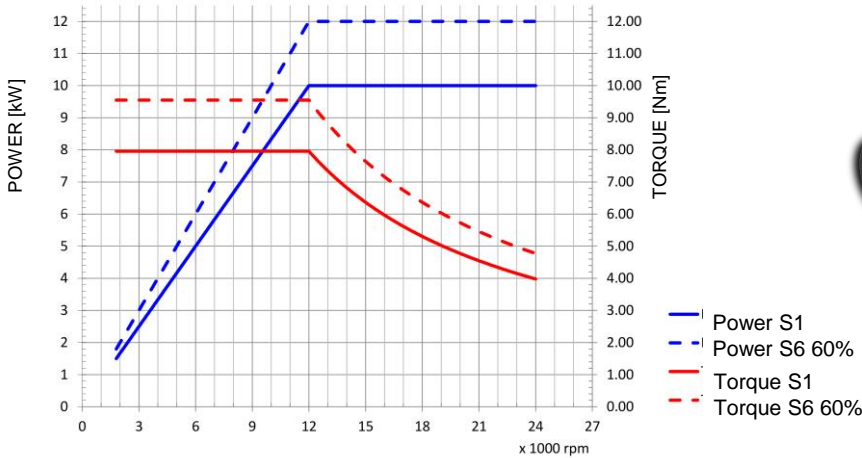

Motor code: **COMTC710025**

Power S1: 10.0 Kw (S1) @ 12000 rpm

Power S6: 12.0 Kw (S6) @ 12000 rpm

Voltage: 380V (option 220V)

Poles: 4

Max speed: 24000 rpm @ 800 Hz

Bearings: Ceramic, front and rear

Power [kW]	Duty Cycle	Base speed [rpm]	Base freq. [Hz]	Base voltage Δ [V]	Base voltage Y [V]	Protection	Ins. Cl.
10.0/12.0	S1/S6-60%	12000	400	380	380	IP54	F
Min speed [rpm]	Max speed [rpm]	Max freq. [Hz]	Absorb. Δ [A]	Absorb. Y [A]	Part number on nameplate		
3000	24000	800	20.0/24.0	20.0/24.0	COMTC710025		
Balancing: G2.5 - ISO 1940 @ maximum motor speed	Balancing type	Foot type	Foot type	Foot type	Peso / weight		
		full key	full key	full key	30.66 kg		
Tolerance non quotati / unlisted tolerances: ±0.5mm Smussi non quotati / unlisted chamfers: +0.5mm							
rev. n°	description	date	signature				
00	Emissione	01/02/2017	D. Bottarel				
drawn - date	approved - date	checked - date	sostituisce il	date	signature	Customer	Title
D. Bottarel - 01/02/2017	S. Peris - 01/02/2017	S. Peris - 01/02/2017	sostituisce il	01/02/2017	D. Bottarel	Catalogo	ATC71-C-ISO30-LN-4P
				folgio / sheet	scala	Drawing code	Drawing n°
				1 / 1	1:4	COMTC710025	5065
				A4			

ATC71-C-HSK63F-SN

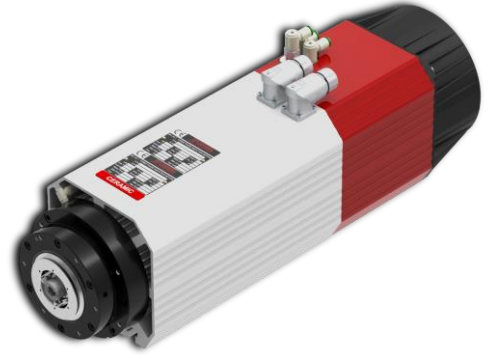

ATC71-C TORQUE AND POWER CURVES

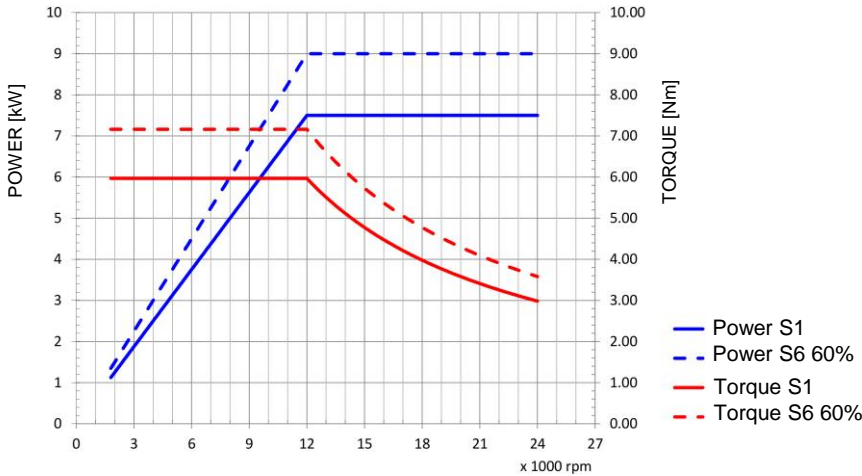

Motor code: **COMTC710028**

Power S1: 7.5 Kw (S1) @ 12000 rpm
 Power S6: 9.0 Kw (S6) @ 12000 rpm
 Voltage: 380V (option 220V)
 Poles: 2
 Max speed: 24000 rpm @ 400 Hz
 Bearings: Ceramic, front and rear

Air inlet pressurization 6 bar Ø8mm
(Automatic cone cleaning included)

Tool-holder release 6 bar Ø8mm

Tool-holder hook-up 6 bar Ø8mm

Electric fan

Pneumatic connectors

Power connector

Signal connector

HSK F63 Taper 1:10

Use only nuts for T-slots. UNI 5531

Power [kW]	Duty Cycle	Base speed [rpm]	Base freq. [Hz]	Base voltage Δ [V]	Base voltage Y [V]	Protection	Ins. Cl.
7.5-9.0	S1/S6-60 %	12000	200	380	380	IP54	F
Min speed [rpm]	Max speed [rpm]	Max freq. [Hz]	Absorb. Δ [A]	Absorb. Y [A]	Part number on nameplate		
3000	24000	400	16.0/19.2	16.0/19.2	COMTC710028		
Balancing: G2.5 - ISO 1940 @ maximum motor speed		Balancing type	Foot type	Foot type	Peso / weight		
			⊕	⊕	28.14 kg		
Tolerance non quotati / unlisted tolerances: ±0.5mm Smussi non quotati / unlisted chamfers: +0.5mm							
rev. n°		description		date	signature		
00		Emissione		01/02/2017	D. Bottarel		
drawn - date				approved - date	checked - date	sostituisce il	
D. Bottarel - 01/02/2017				S. Peris - 01/02/2017	S. Peris - 01/02/2017	sostituito dal	
Title				Customer			
ATC71-C-HSK63F-SN				Catalogo			
Drawing code				Drawing n°			
COMTC710028				5068			
foglio / sheet		scala		A4			
1 / 1		1:4					

Power connector	
1	U
2	V
3	W
GND	Ground
A	Fan (L) 220V
B	Thermal protection
C	Thermal protection
D	Fan (N) 220V

Signal connector	
1	S1
2	S2
3	S3 tacho
4	S4
5	S5
6	0 V
7	+24V DC

ATC71-C-HSK63F-SN

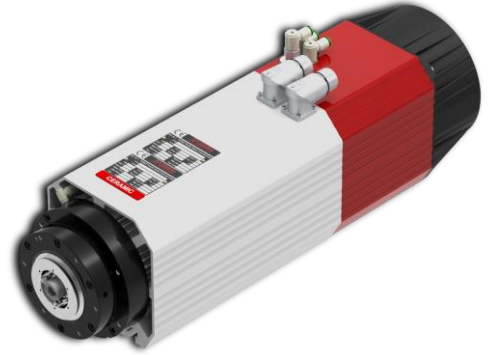

ATC71-C TORQUE AND POWER CURVES

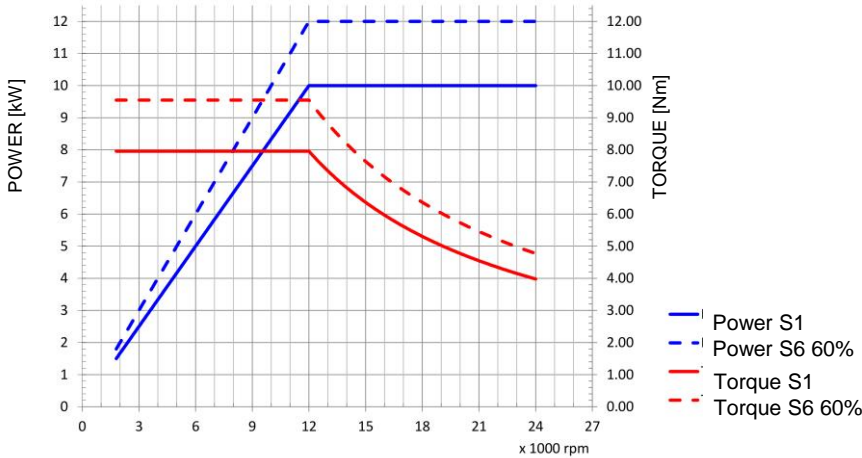

Motor code: **COMTC710026**

Power S1: 10.0 Kw (S1) @ 12000 rpm
 Power S6: 12.0 Kw (S6) @ 12000 rpm
 Voltage: 380V (option 220V)
 Poles: 4
 Max speed: 24000 rpm @ 800 Hz
 Bearings: Ceramic, front and rear

Technical drawing details:
 Air inlet pressurization 6 bar Ø8mm (Automatic cone cleaning included)
 Tool-holder release 6 bar Ø8mm
 Tool-holder hook-up 6 bar Ø8mm
 Electric fan
 HSK F63 Taper 1:10
 Pneumatic connectors
 Power connector
 Signal connector

Technical drawing dimensions:
 181.3, 179, 145, 70.5, 8 H8, 80, 116, 144, 16, 10, 16.5

Use only nuts for T-slots. UNI 5531

Power [kW]	Duty Cycle	Base speed [rpm]	Base freq. [Hz]	Base voltage Δ [V]	Base voltage Y [V]	Protection	Ins. Cl.
10.0/12.0	S1/S6-60%	12000	400	380	380	IP54	F
Min speed [rpm]	Max speed [rpm]	Max freq. [Hz]	Absorb. Δ [A]	Absorb. Y [A]	Part number on nameplate		
3000	24000	800	20.0/24.0	20.0/24.0	COMTC710026		
Balancing: G2.5 - ISO 1940 @ maximum motor speed	Balancing type	Foot type	Foot type	Foot type	Peso / weight		
		⊙	⊙	⊙	26.80 kg		
Tolerance non quotati / unlisted tolerances: ±0.5mm Smussi non quotati / unlisted chamfers: +0.5mm		Balancing type		∇ = 0.8/∇	∇ = 3.2/∇	∇ = 12.5/∇	∇ = ∇/∇
rev. n°	description	date	signature				
00	Emissione	01/02/2017	D. Bottarel				
drawn - date		approved - date	checked - date	sostituisce il	foglio / sheet		
D. Bottarel - 01/02/2017		S. Peris - 01/02/2017	S. Peris - 01/02/2017	sostituito dal	1 / 1		
				scala		A4	
				1:4			

Power connector	
1	U
2	V
3	W
GND	Ground
A	Fan (L) 220V
B	Thermal protection
C	Thermal protection
D	Fan (N) 220V

Signal connector	
1	S1
2	S2
3	S3 tacho
4	S4
5	S5
6	0 V
7	+24V DC

TEKnomotor
 Teknomotor S.r.l.
 Via Agnèga 31, I-32038 Quero Vias (BL)
 www.teknomotor.com

Title		ATC71-C-HSK63F-SN-4P	
Customer		Catalogo	
Drawing code		COMTC710026	
Drawing n°		5066	

Il presente disegno è di proprietà esclusiva di Teknomotor S.r.l. La riproduzione totale o parziale e la divulgazione a terzi, senza nostro esplicito consenso scritto, verrà perseguito secondo i termini di legge in vigore.

ATC71-C-HSK63F-LN

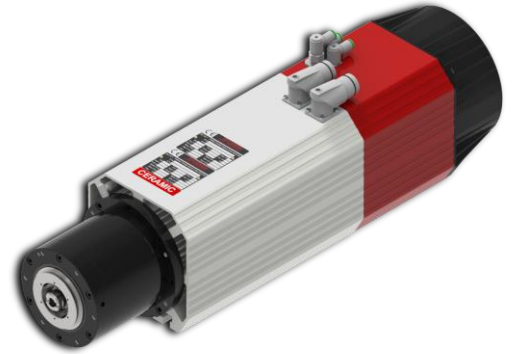

ATC71-C TORQUE AND POWER CURVES

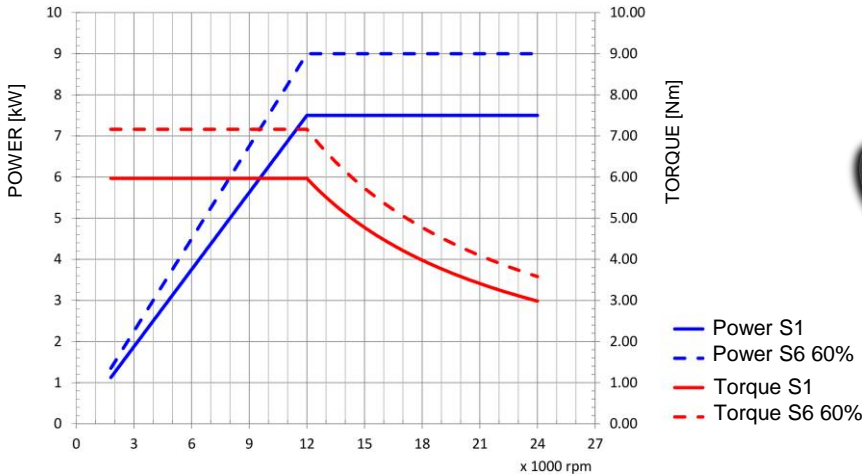

Motor code: **COMTC710005**

Power S1: 7.5 Kw (S1) @ 12000 rpm
 Power S6: 9.0 Kw (S6) @ 12000 rpm
 Voltage: 380V (option 220V)
 Poles: 2
 Max speed: 24000 rpm @ 400 Hz
 Bearings: Ceramic, front and rear

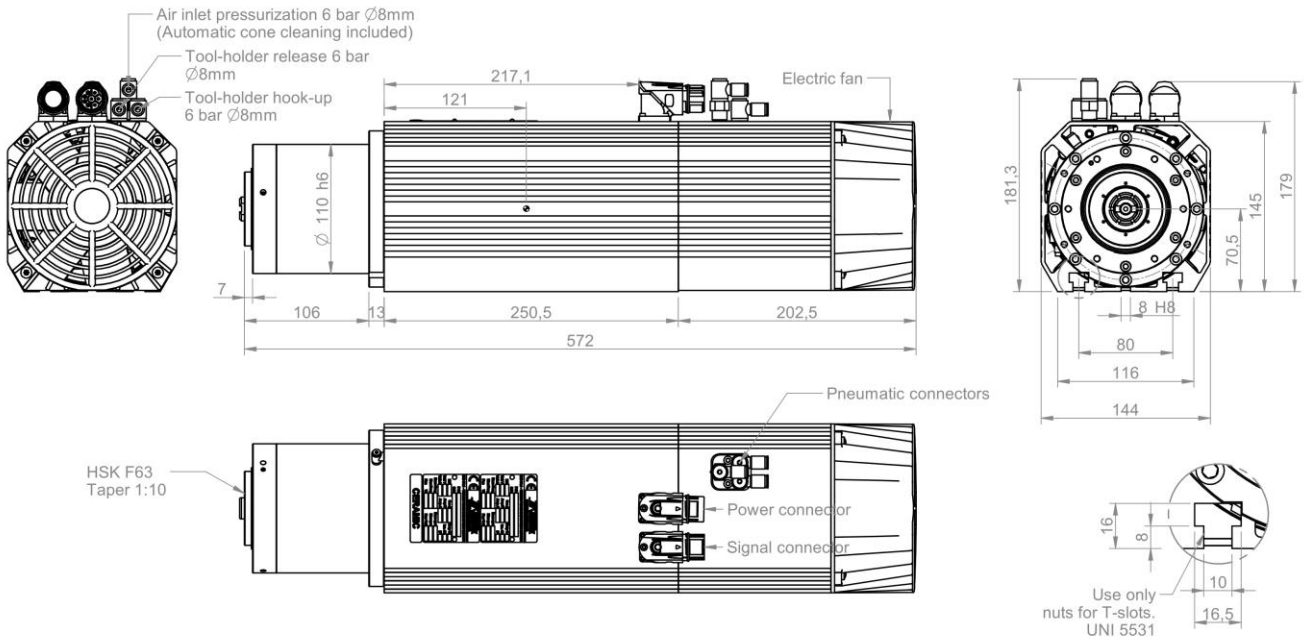

Power connector	
1	U
2	V
3	W
GND	Ground
A	Fan (L) 220V
B	Thermal protection
C	Thermal protection
D	Fan (N) 220V

Signal connector	
1	S1
2	S2
3	S3 tacho
4	S4
5	S5
6	0 V
7	+24V DC

Power [kW] 7.5/9.0	Duty Cycle S1/S6-60 %	Base speed [rpm] 12000	Base freq. [Hz] 200	Base voltage Δ [V] 380	Protection IP54	Ins. Cl. F
Min speed [rpm] 3000	Max speed [rpm] 24000	Max freq. [Hz] 400	Absorb. Δ [A] 16.0/19.2	Absorb. Y [A] 16.0/19.2	Part number on nameplate COMTC710005	
Balancing: G2.5 - ISO 1940 @ maximum motor speed		Balancing type	Tool type full key	Tool type half key	Peso / weight 32.10 kg	
Tolerance non quotati / unlisted tolerances: ±0.5mm Smussi non quotati / unlisted chamfers: ±0.5mm			vvv = 0.8 √	vv = 3.2 √	v = 12.5 √	- = √
rev. n° 00	description Emissione		date 05/09/2014	signature D. Bottarel		
Title ATC71-C-HSK63F-LN			Customer Catalogo			
Drawing code COMTC710005			Drawing n° 3291			
drawn - date D. Bottarel - 05/09/2014	approved - date S. Peris - 05/09/2014	checked - date S. Peris - 05/09/2014	sostituisce il sostituito dal		foglio / sheet 1 / 1	scala 1:4

ATC71-C-HSK63F-LN

ATC71-C TORQUE AND POWER CURVES

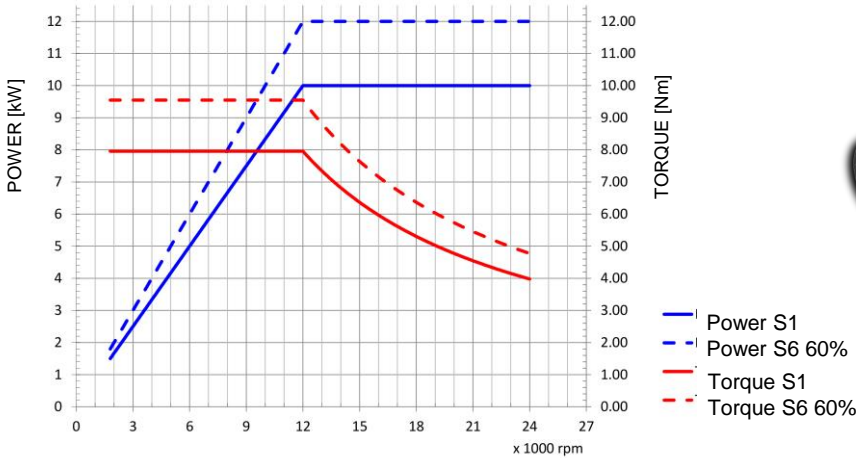

Motor code: **COMTC710027**

Power S1: 10.0 Kw (S1) @ 12000 rpm
 Power S6: 12.0 Kw (S6) @ 12000 rpm
 Voltage: 380V (option 220V)
 Poles: 4
 Max speed: 24000 rpm @ 800 Hz
 Bearings: Ceramic, front and rear

Technical drawing of the motor showing dimensions and labels. Labels include: Air inlet pressurization 6 bar Ø8mm (Automatic cone cleaning included), Tool-holder release 6 bar Ø8mm, Tool-holder hook-up 6 bar Ø8mm, Electric fan, Pneumatic connectors, Power connector, Signal connector, HSK F63 Taper 1:10.

Technical drawing of the motor showing dimensions and labels. Labels include: Use only nuts for T-slots. UNI 5531.

Power [kW]	Duty Cycle	Base speed [rpm]	Base freq. [Hz]	Base voltage Δ [V]	Base voltage Y [V]	Protection	Ins. Cl.
10.0/12.0 S1/S6-60%		12000	400	380	380	IP54	F
Min speed [rpm]	Max speed [rpm]	Max freq. [Hz]	Absorb. Δ [A]	Absorb. Y [A]	Part number on nameplate		
3000	24000	800	20.0/24.0	20.0/24.0	COMTC710027		
Balancing: G2.5 - ISO 1940 @ maximum motor speed		Balancing type	Foot type	Foot type	Peso / weight		
			full key	full key	30.76 kg		
Tolerance non quotati / unlisted tolerances: ±0.5mm Smussi non quotati / unlisted chamfers: +0.5mm							
rev. n°	description		date	signature			
00	Emissione		01/02/2017	D. Bottarel			
drawn - date						approved - date	checked - date
D. Bottarel - 01/02/2017						S. Peris - 01/02/2017	S. Peris - 01/02/2017
sostituisce il						sostituito dal	
D. Bottarel - 01/02/2017						S. Peris - 01/02/2017	
Title				Customer			
ATC71-C-HSK63F-LN-4P				Catalogo			
Drawing code				Drawing n°			
COMTC710027				5067			
foglio / sheet		scala		A4			
1 / 1		1:4					

CABLE SETS

The connection cables provided by Teknomotor for its ATC are in **mobile lying, shielded** and **oil-proof** (PUR). All the wires are numbered and complete of insulated end ferrules. Moreover, the connectors are wired by professional companies, which ensure the compliance through testing. Teknomotor can even provide the connector with the PINs to wire, but do not recommend it.

I cavi di collegamento forniti da Teknomotor per i propri ATC sono in **posa mobile**, sono **schermati** e **resistenti all'olio** (PUR). Tutti i fili sono numerati e dotati di puntalini isolati. I connettori sono inoltre cablati da aziende specializzate, che ne garantiscono la conformità tramite collaudo. Teknomotor può anche fornire il connettore completo di PIN da cablare, ma lo sconsigliamo.

Die von Teknomotor mitgelieferten Verbindungskabel für die eigenen ATC werden **mobil verlegt**, sind **geschirmt** und **ölbeständig** (PUR). Alle Drähte sind durchnummeriert und mit isolierten Spitzen versehen. Die Verbinder wurden zudem von Fachbetrieben verkabelt, die durch Abnahme die Konformität zusichern. Teknomotor kann den Verbinder auch mit zu verkabelndem PIN anliefern, es ist jedoch nicht ratsam.

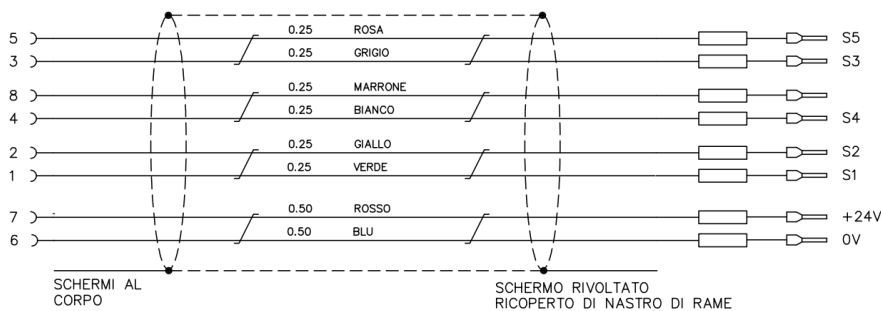
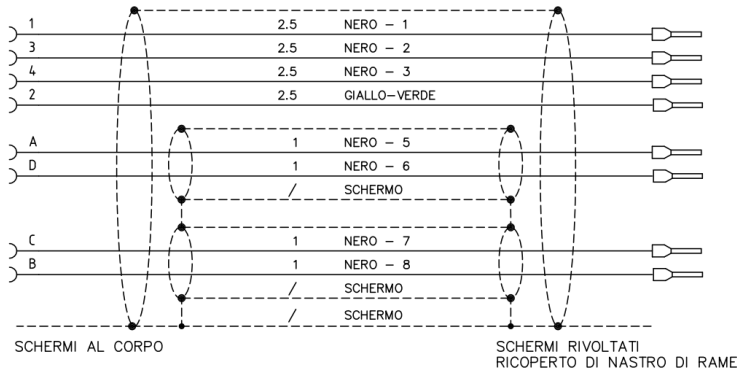

MAX CURRENT: 24A

CABLE SET LENGTHS AVAILABLE [m]	ORDERING CODE
2	CAS0001
5	CAS0002
10	CAS0003
15	CAS0004
20	CAS0005

TOOL HOLDERS – PORTAUTENSILI – WERKZEUGTRÄGER

The tool holders are provided by Teknomotor only on demand.

The ISO 30 toolholders are supplied complete with pull stud and balanced nut. The HSK 63F toolholders are supplied complete with balanced nut.

I portautensili vengono forniti da Teknomotor solo su richiesta.

I portautensili ISO 30 vengono forniti completi di codolo e ghiera equilibrata.

I portautensili HSK 63F vengono forniti completi di ghiera equilibrata.

Die Werkzeugträger werden nur auf Anfrage von Teknomotor geliefert.

Die Werkzeugträger ISO 30 werden mit Einspannzapfen und ausgewuchtetem Schraubstock angeliefert.

Die Werkzeugträger HSK 63F werden mit ausgewuchtetem Schraubstock angeliefert.



TOOLHOLDER TYPES	THREAD DIMENSION	TAPER	ORDERING CODE	RENDER VIEW
ISO 30	M40 x 1.5	ER 32	TOH0105A	
HSK 63F	M40 x 1.5	ER 32	TOH0205A	
PULL STUD for ISO 30 tool holder	M12	-	TOH0151A	
NUT GTS32	M40 x 1.5	ER32	GHS0205RA	
COLLETS ER32	-	ER32	PIN05<XX>00E Where XX is the internal diameter of the collet [mm]	

FORKS

The forks for toolholders supplied by Teknomotor are made of ABS, a very lightweight, elastic and resistant thermoplastic polymer.

Le forks per portautensili fornite da Teknomotor sono realizzate in ABS, un polimero termoplastico estremamente leggero, elastico e resistente.

Die von Teknomotor unsere Werkzeugklammern sind aus ABS, ein thermoplastisch Polymer extem leicht, elastisch und resistant.

FORK TYPE	ORDERING CODE	RENDER VIEW
ISO30	TOH0181A	
HSK63F	TOH0281A	

INVERTERS

The three phases inverters are suitable for every industrial application. They work with three phases line voltage of 380-400 V.

Gli inverter trifase sono adatti per ogni applicazione industriale. Funzionano con tensione di rete 380-400 V trifase.

Die Dreiphasen-Inverter sind für industrielle Einsätze geeignet. Sie werden mit einer dreiphasigen Netzspannung von 380-400V betrieben.



TEKNOMOTOR ORDERING CODE	TECHNICAL DATA				SPINDLE TYPES	
	Power [kVA]	Current [A]	Freq. [Hz]	T _{MAX} [°C]	2 poles	4 poles
INV011207	5.5	14.3	50	50	COMTC710001 COMTC710007	-
INV011208	7.5	17.0	50	50	COMTC710004 COMTC710006 COMTC710008 COMTC710023	-
INV011209	11.0	27.7	50	50	COMTC710003 COMTC710005 COMTC710009 COMTC710028	-
INV022109	11.0	16.0	50		-	COMTC710020 COMTC710021 COMTC710023
INV022110	15.0	21.5	50		-	COMTC710014 COMTC710015 COMTC710018 COMTC710022
INV022112	22.0	30.0	50		-	COMTC710024 COMTC710025 COMTC710026 COMTC710027

ATC71 CATALOGUE REVISION TABLE

Doc. Code	Rev. n°	Rev. Date	Rev. Description	Rev. Author
DOC.C.003	00	28/02/2017	1 st Emission	E. Gaspari



TEKNOMOTOR s.r.l.

Via Argenega, 31 – 32038 Quero Vas (BL) ITALY

tel. +39 0439 787950 – fax. +39 0439 780147

Partita IVA 00929130250

info@teknomotor.com

www.teknomotor.com

**AZIENDA CON SISTEMA
DI GESTIONE QUALITÀ
CERTIFICATO DA DNV GL
= ISO 9001 =**